

UAB

Universitat Autònoma de Barcelona



umweltbundesamt



JUNTA DE ANDALUCIA
CONSEJERÍA DE MEDIO AMBIENTE



Internal report

Mapping sensitivity to desertification (DISMED)

Final report
Version 2

Prepared by:
Francisco Domingues, Jaume Fons-Esteve

14.01.2008

Project manager:
Anna Rita Gentile



Universitat Autònoma de Barcelona
Edifici C – Torre C5 4^a planta
08193 Bellaterra (Barcelona)
Spain, EU

Contact: etclusi@uab.cat

TABLE OF CONTENTS

4

1	Background and scope of the report	3
2	Methodology	3
2.1	Overview	3
2.2	Climate quality index	4
2.3	Soil quality index	5
2.4	Vegetation quality index	7
2.5	Final layer	7
2.6	Methodology Scheme	8
3	Maps	10
3.1	Vegetation layer	10
3.2	Soil layer	11
3.3	Climate Layer	13
3.4	Final map	14

Annexes

Annex 1. Reference documents	7
Annex 2. Acronyms	8

1 BACKGROUND AND SCOPE OF THE REPORT

The European Topic Centre on Terrestrial Environment (ETC-TE) has been asked by the European Environment Agency (EEA) to support the development of a sensitivity mapping on desertification and drought in the Mediterranean countries at scale 1 : 1.000.000. This is part of the project Desertification Information System to Support National Action Programmes in the Mediterranean (DISMED), where the EEA is involved.

Since March 2002 a Working group on sensitivity mapping on desertification and drought has been established with the mandate of defining technical specification of the cartography.

By the end of June 2003 the ETC prepared an assessment report on the feasibility of the map where it was concluded that a minimum data sets and methodology existed for Europe except for the socio-economic layer. Since no new data has been available, the map developed corresponds to the minimum requirements described in the above mentioned report.

Now on final 2007 the ETC LUSI was proposed to update the DISMED map with the new information on Soils (Soil Database V2 JRC) and with CLC 2000.

The geographic coverage of this update has taken into account the following criteria:

- All the countries eligible to Annex IV and Annex V;
- From the previous groups only those countries where data is available.

2 METHODOLOGY

2.1 OVERVIEW

The adopted methodology is inspired by the one developed in the framework of the MEDALUS project (Mediterranean Desertification And Land Use). Sensitivity to the desertification of the different spatial homogeneous units is defined by an index (ISD: index of sensitivity to the Desertification) obtained from the geometrical average of three indexes of the soil quality, climate and vegetation. Land planning and socio-economic aspects have not been included because further work is required in order to test methodologies implemented at regional or national level.

2.2 CLIMATE QUALITY INDEX

Climatic aspects has been analysed trough the Aridity Index (AI), using the methodology developed by FMA in accordance with the following formula

$$AI = P / PET$$

where:

AI = Aridity index

P = Yearly mean rainfall

PET = Yearly mean potential evapotranspiration

Within this index, the territory is classified as showed in the following table:

CQI	Climatic zones	Classification
< 0.05	Iper - arid	2
0.05 - 0.20	Arid	1,75
0.20 - 0.50	Semi - arid	1,50
0.50 - 0.65	Dry sub - humid	1,25
> 0.65	Humid	1

2.3 SOIL QUALITY INDEX

The soil quality index (SQI), developed by OSS, is based on four parameters:

- parental material
- soil depth
- texture
- slope

SQI is given by the geometric average of the indexes for the four parameters.

$$SQI : (Parental\ Material \times Depth \times Texture \times slope)^{\frac{1}{4}}$$

In case local data are not available for a single parameter, only the remaining parameters were used.

2.3.1 Parent material

Parental material has been classed in three classes as below:

parental material	score
Coherent parental material : limestone, dolomite, non friable sandstone, hard limestone layer	1
Parental material moderately coherent : Marno-limestone, friable sandstone	1.5
Parental material soft to friable : Calcareous clay, clay, sandy formation, alluvium and colluviums,	2

2.3.2 Soil depth

The following classes were proposed:

Classes	Description	Score
Very deep	Soil thickness higher than 1.2m with a substrate non penetrable by the roots or thickness higher than 1m on a movable substrate	1
Moderate to deep	Depth from 0.8 to 1.2m with a coherent substrate or from 0.5 to 1m with a movable substrate	1.33
Not deep	Depth from 0.5 to 0.8m with a coherent substrate or from 0.3 to 0.5m with a movable substrate	1.66
Very thin	Depth lower than 0.3m	2

Because soil depth is not included in the Soil Database, and pedotransfer rules were not available, the following approach was adopted

parental material	score
Fluvisols	1
All other groups	1.5
Leptosols and regosols	2

2.3.3 Soil texture

Soil texture was grouped as follows:

Classes	Description	Score
Texture not very light to average	loamy-sandy, sandy-loamy, balanced	1
Texture thin to average	loamy-clayey, clayey-sandy, sandy-clayey	1.33
Thin texture	clayey clayey-loamy	1.66
Coarse texture	Sandy to very sandy	2

When two classes concurred in the same polygon the arithmetic mean was used.

2.3.4 Slope

The following classes were proposed:

Classes	Description	Score
< 6	Gentle	1
6 – 18	Not very gentle	1.33
9 – 35	Abrupt	1.66
> 35	very abrupt	2

Because the classes given by the Soil Database didn't fit to the ones proposed, the final classification adopted was as follows:

Class	Description	Score
a	Level (dominant slope ranging from 0 to 8 %)	1
b	Sloping (dominant slope ranging from 8 to 15 %)	1.33
c	Moderately steep (dominant slope ranging from 15 to 25 %)	1.66
d	Steep (dominant slope over 25 %)	2

When two classes concurred in the same polygon the arithmetic mean was used.

2.4 VEGETATION QUALITY INDEX

For the Vegetation Quality Index, a subgroup of WG! submitted a reclassification of Corine Land Cover (CLC90) third level classes, assigning each CLC class a value for each of these 4 parameters:

- erosion protection,
- resistance to drought,
- ground coverage,
- resistance to fire,

using the same range of values for all 4 parameters:

- 0 (excluded from further consideration);
- 1 (good)
- 1.5 (moderate)
- 2 (bad)

VQI is given by the geometric average of the indexes for the four parameters.

$$VQI : (ErosionProtection \times ResistDrought \times Coverage \times ResistFire)^{\frac{1}{4}}$$

2.5 FINAL LAYER

The final overall ISD index is obtained as a geometrical average of the quality indexes.

$$ISD = (SQI * CQI * VQI)^{\frac{1}{3}}$$

Finally the ISD is grouped according to the following classes of sensitivity to desertification:

Classes	SDI (Sensitivity desertification index)	Description
1	< 1,2	Non affected areas or very low sensitive areas to desertification
2	1,2 ≤ ISD < 1,3	Low sensitive areas to desertification
3	1,3 ≤ ISD < 1,4	Medium sensitive areas to desertification
4	1,4 ≤ ISD < 1,6	Sensitive areas to desertification
5	ISD ≥ 1,6	Very sensitive areas to desertification

2.6 METHODOLOGY SCHEME



Methodology Scheme

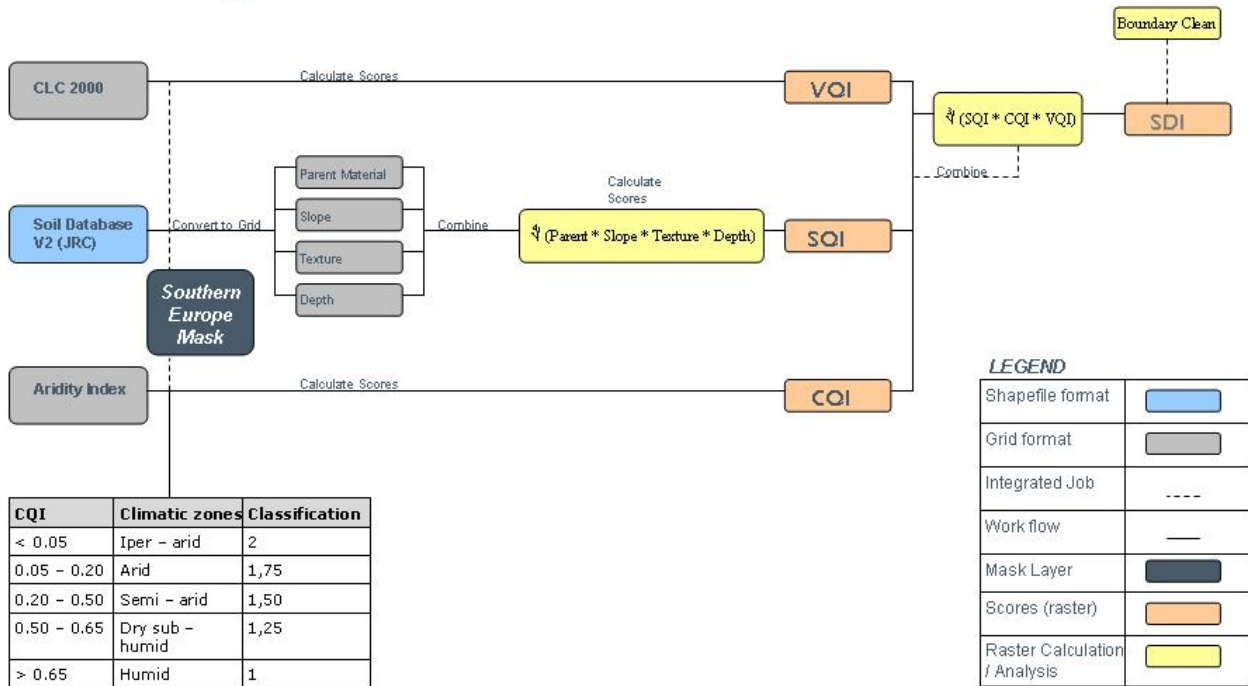

Data sources for the map

	Climate	Soil	Vegetation
<i>Database name</i>	Aridity index	Soil quality index	Vegetation index
<i>Produced by</i>	FMA	ETC-LUSI	ETC-LUSI
<i>Geographic extent</i>	Southern Europe (AL, BA, BG, CS, ES, FR, GR, HR, IT, PT, RO, SI)	Southern Europe (AL, BA, BG, CS, ES, FR, GR, HR, IT, PT, RO, SI)	Southern Europe (AL, BA, BG, CS, ES, FR, GR, HR, IT, PT, RO, SI)
<i>Format</i>	ArcInfo GRID	ArcInfo Shapefile	ArcInfo GRID
<i>Data model</i>	Raster	Vector	Raster
<i>Projection</i>	Geographic (decimal degrees) Parameters unknown (Spheroid & datum)	Lambert Azimuthal	Lambert Azimuthal
<i>Source</i>	<ul style="list-style-type: none"> • Temp. events (FAOCLIM Meteorological stations) • Rainfall events (FAOCLIM Meteorological stations) • DEM (GTOPO30) • Sea distances database (FMA) • Lat/Long database (FMA) 	Soil Database V2 (JRC). Available at EEA.	CLC 2000 (EEA)

3 MAPS

3.1 VEGETATION LAYER

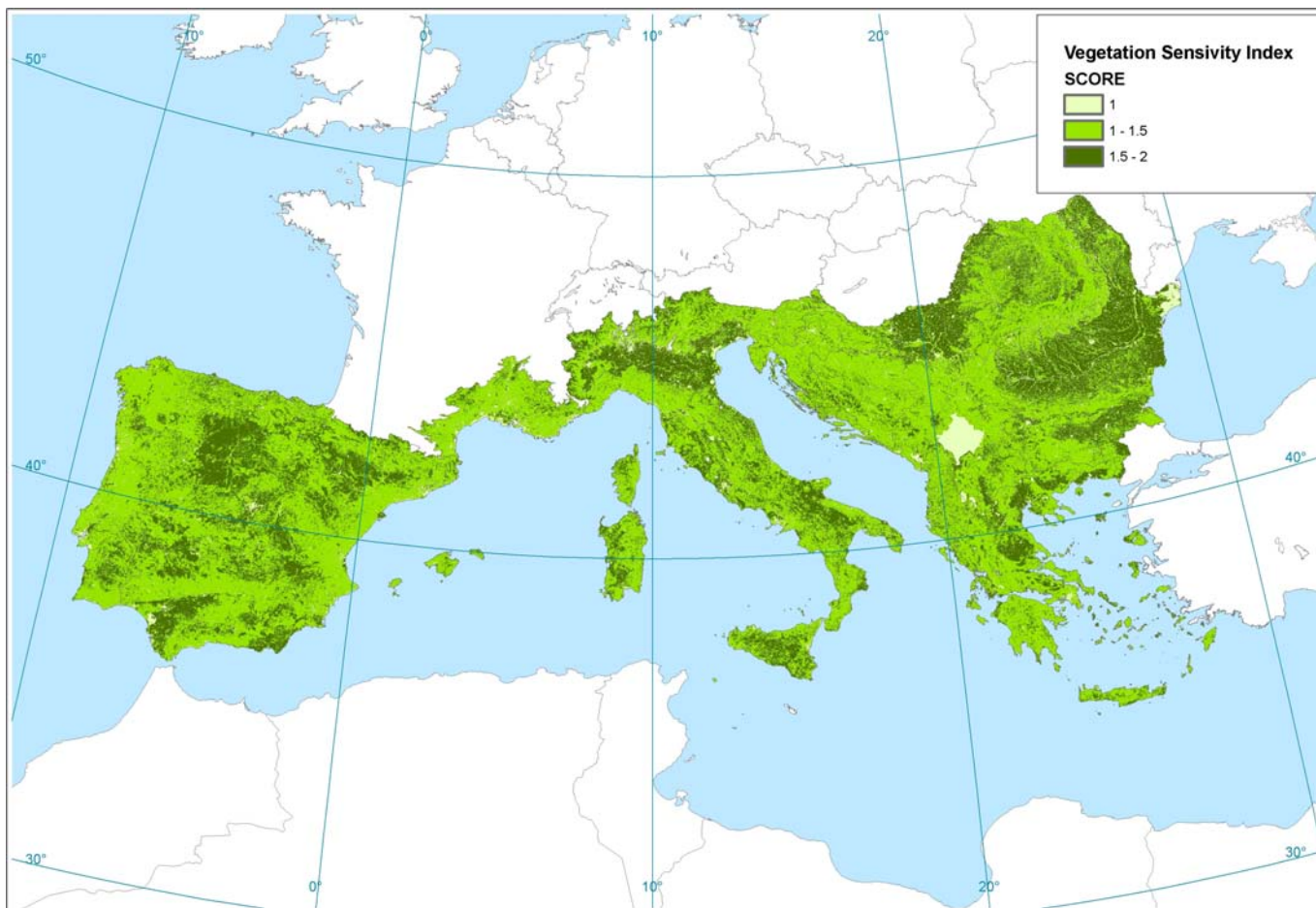

3.2 SOIL LAYER

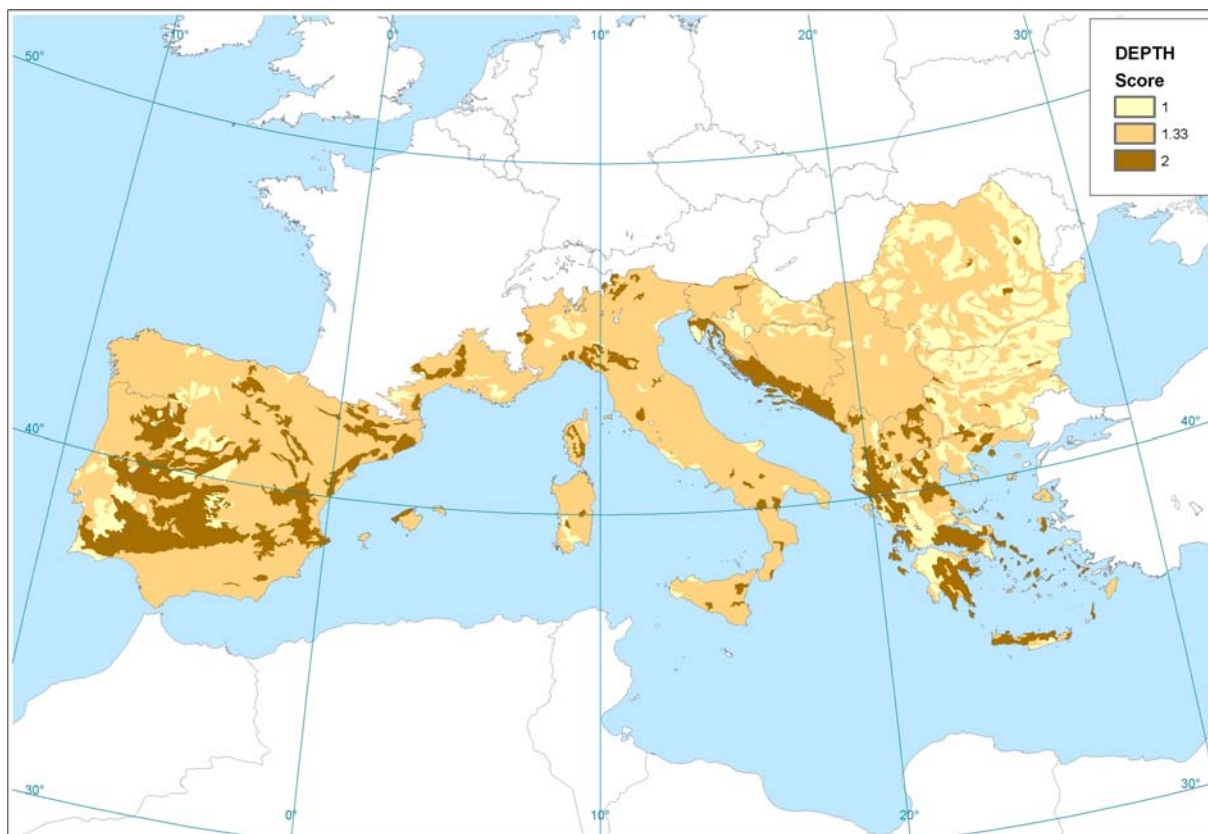
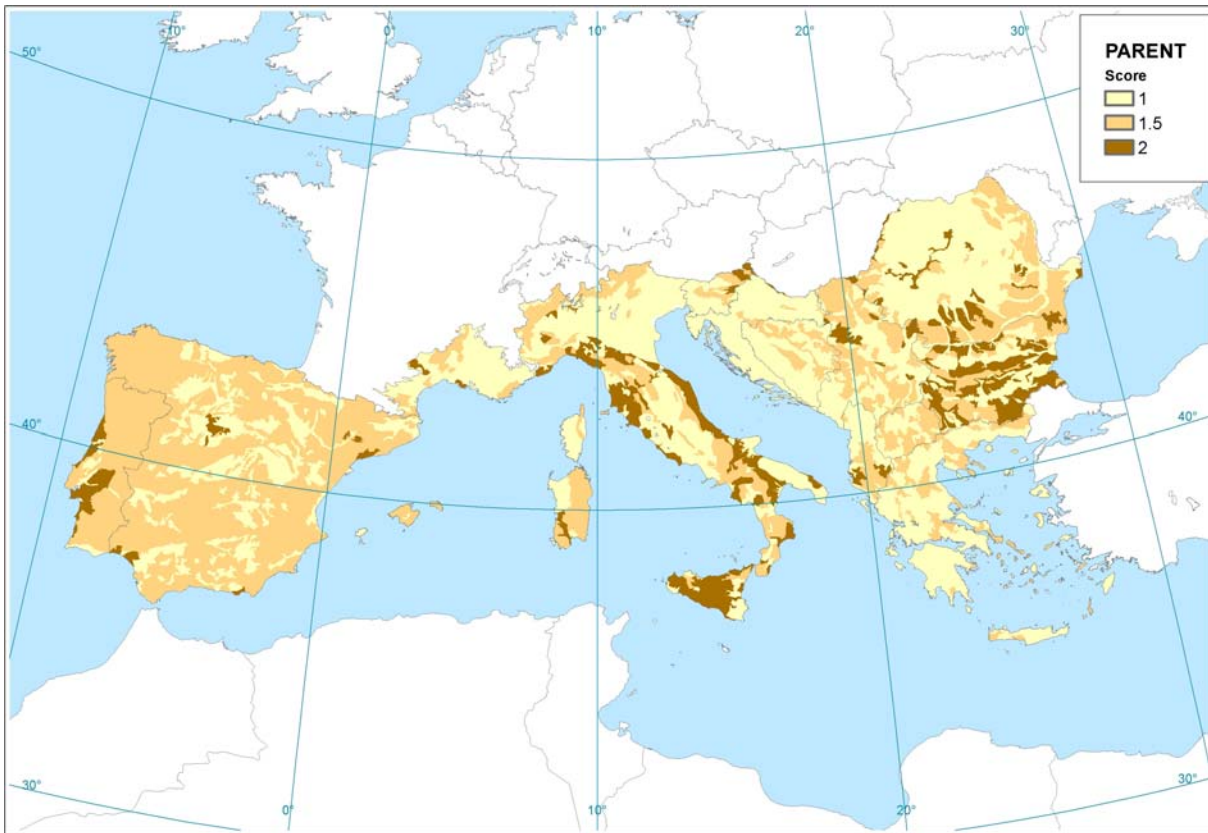

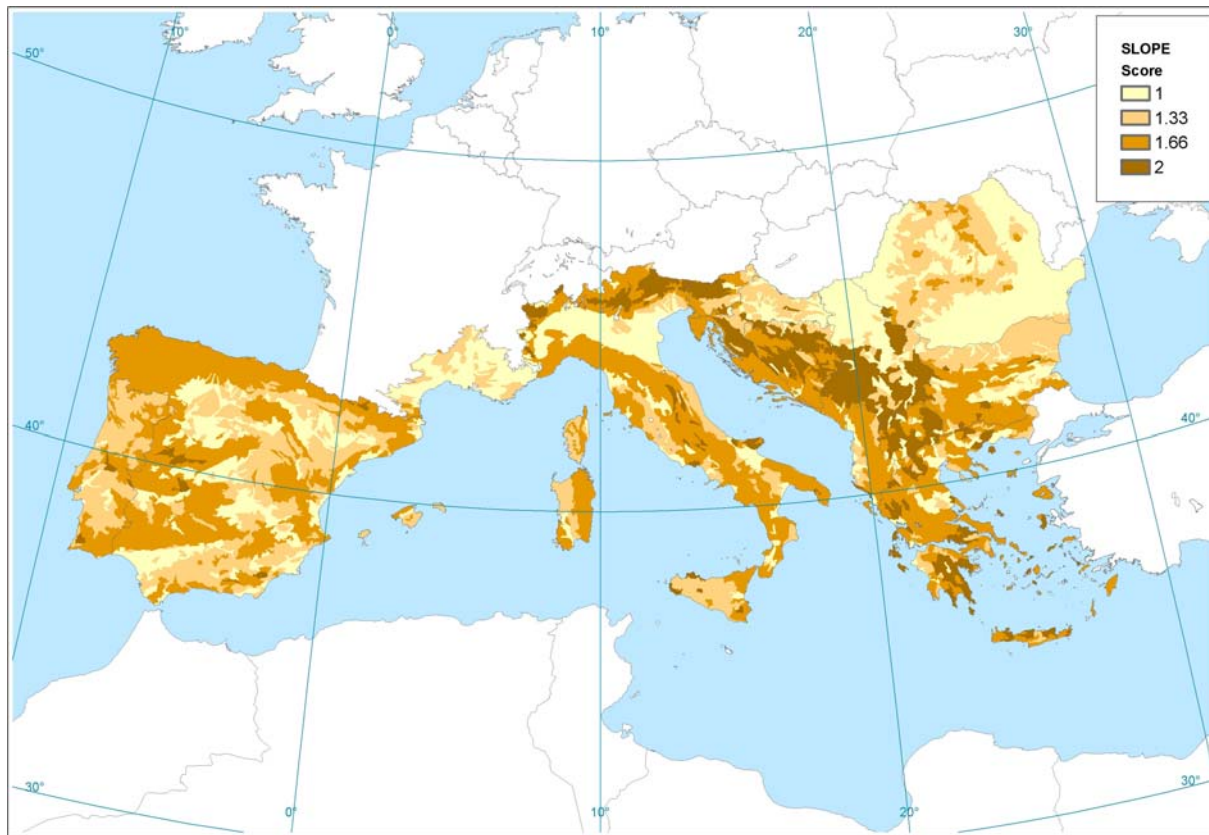
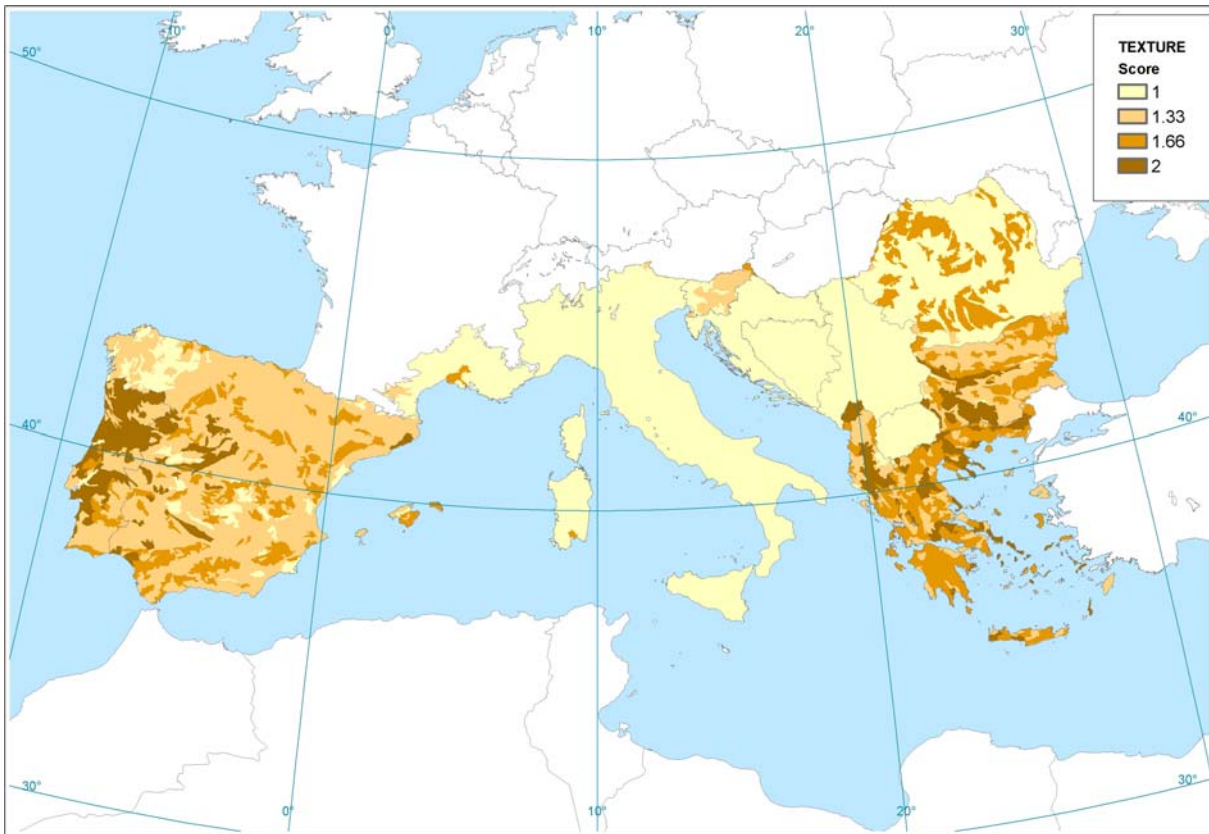

3.3 CLIMATE LAYER

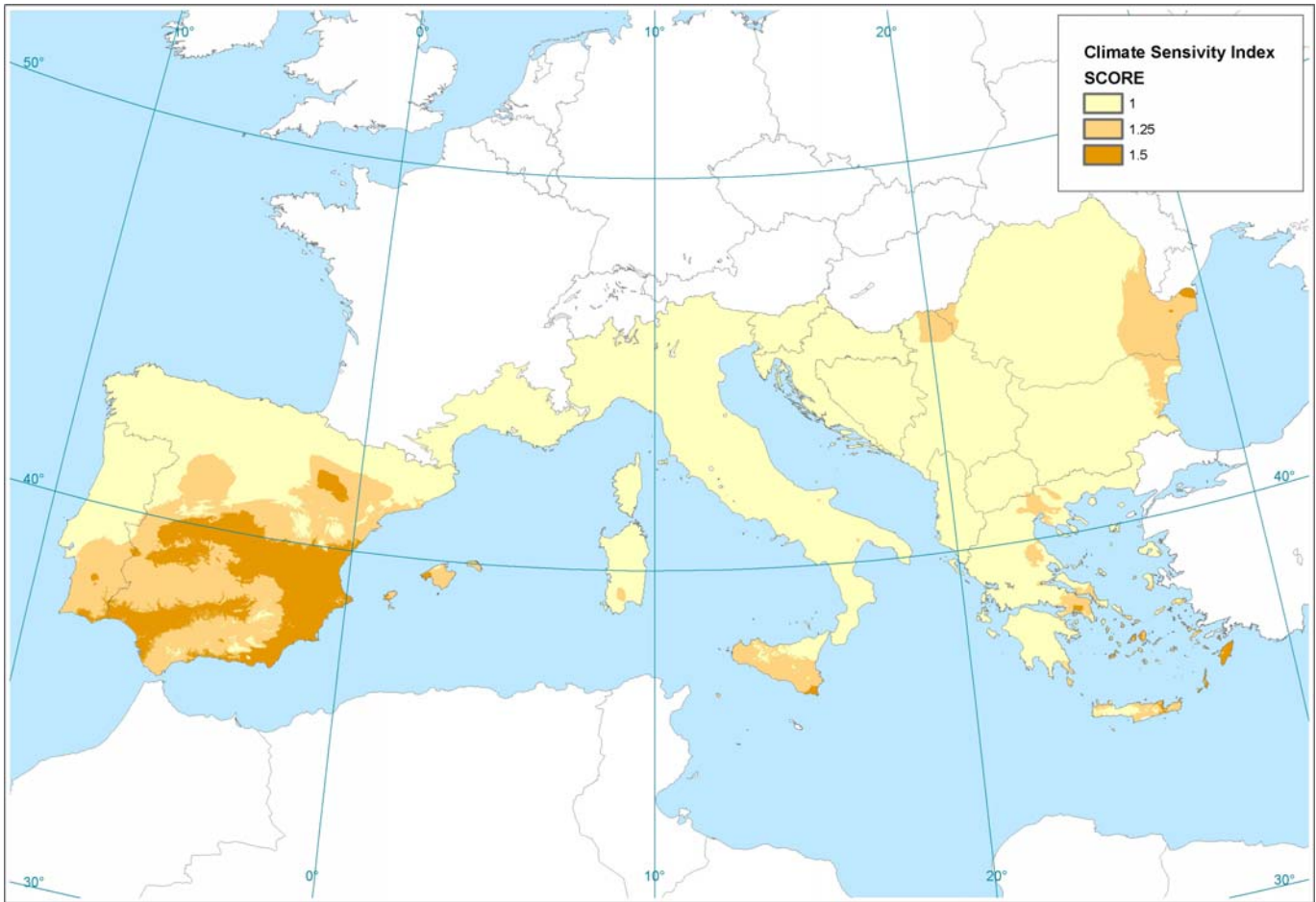

3.4 FINAL MAP

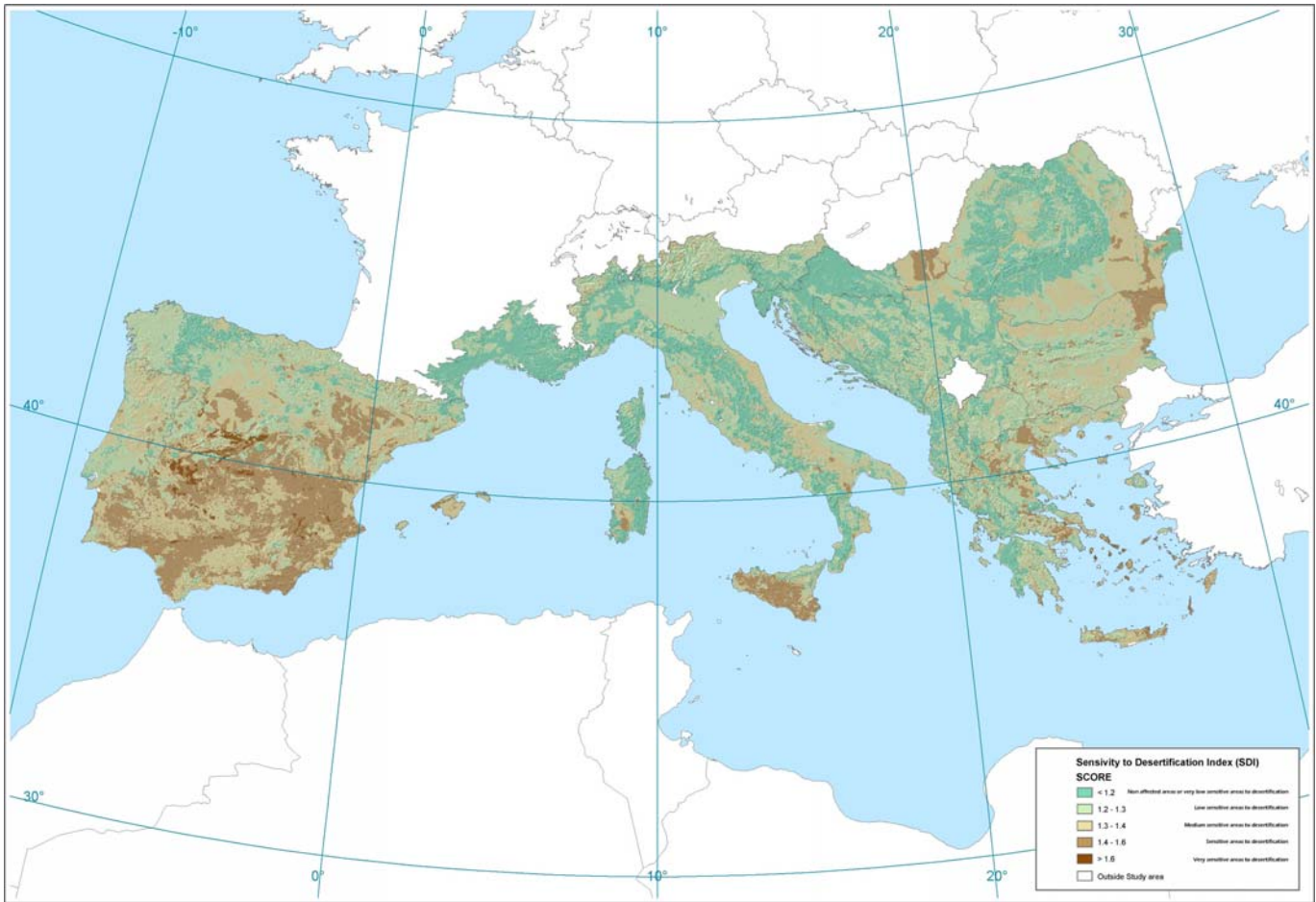

Annex 1. Acronyms

CLC	Corine Land Cover
DEM	Digital Elevation Model
EEA	European Environment Agency
ESB	European Soil Bureau
ETC-TE	European Topic Centre on Terrestrial Environment
FMA	Applied Meteorological Foundation
JRC	Joint Research Center
OSS	Sahara and Sahel Observatory