

Internal Report

3.1. Environmental Accounting

Methodological guidebook Data processing of land cover flows

Prepared by:
Oscar Gómez & Ferran Páramo

July 2005

Project manager:
Jean-Louis Weber



European Topic Centre
Terrestrial Environment

Universitat Autònoma de Barcelona
Edifici C – Torre C5
4^a planta
08193 Bellaterra (Barcelona)
Spain

Contact: etcte@uab.es

European Environment Agency 

TABLE OF CONTENTS

1. Introduction.....	2
1.1. Background.....	2
1.2. Objective.....	2
2. Methodology	3
2.1. From spatial domain to Database	3
2.1.1. Creation of the Reference Grid	4
2.1.2. Integration of Land Cover Change data	5
2.1.3. Integration of Territorial Units	6
2.1.4. Database structure	7
2.2. Changes classification: Land Cover Flows	9
Annex 1: Matrix of land cover flows	11
Annex 2: Definition of land cover flows	15
Annex 3: LEAC Data Model.....	19
Annex 4: LEAC web based Query Tool.....	20
References	22

1. INTRODUCTION

1.1. BACKGROUND

When the Topic Centre on Terrestrial Environment of the EEA was created end of 2001, EUROSTAT proposed to test the draft **LEAC (Land and Ecosystem Accounts)** methodology, in view of its possible implementation with CORINE land cover data and European statistics. Two case studies were agreed upon for two areas where CLC data on changes were available: the European coast (LaCoast project of the JRC, 1975-1990) and 4 countries of Central Europe (Czech Republic, Slovakia, Hungary and Romania) which had made an assessment of CLC for 1975 for the EEA, and also have available the PHARE inventory of 1995.

During the last year the CLC2000 products were made available gradually. This was the first time that most of the European territory was covered by a Land Cover Changes database. The methodology drafted in the two pilot studies was adapted to the new datasets and improved when possible.

The main goal of LEAC is to provide an easy and comprehensive access land cover data showing the 'stock' available for each land cover class in the different Land Cover data, and providing also the changes occurred in the periods between different Land Cover works.

If someone wants to analyze some specific changes, or some available stock in an analysis unit, spatial analysis must be done using GIS software to query exactly Land Cover data in that specific area. So these data are not easy to access because it needs some spatial processing first.

LEAC has already performed the spatial part of a land cover analysis, taking land cover data to alphanumeric data. This way, land cover and changes and land cover may be studied using basic SQL queries.

The way LEAC does this is analyzing land cover data for a minimum spatial unit, and then refer each possible analysis unit to a combination of some of the minimum spatial unit. For each minimum spatial unit, all different land cover data is stored.

LEAC provides also a classification of land cover changes (potentially ...) in land cover flows. This provides a more comprehensive way to analyze changes.

1.2. OBJECTIVE

The objective of this activity is the development of a methodological report detailing the underlying principles of the land cover accounts and the tools and methods developed to produce and analyze them. The present methodological note is divided in two main parts:

- Transformation of spatial data into classic Entity-Relationship database (LEAC database) which allows the quick exploitation of such volume of information.
- Land Cover changes classification into hierarchical Land Cover Flows and its nomenclature.

In the annexes we define the Data Model for the LEAC database and possible applications based on the mining of that database.

2. METHODOLOGY

The methodology on LEAC can be divided in two main steps. In the first one we distribute Land Cover Changes data into several territorial units that will be used later to analyse data and to report the results. The second one concerns on the classification of Land Cover Changes into Land Cover Flows which will determine the final results. This two main steps are described in the following lines.

2.1. FROM SPATIAL DOMAIN TO DATABASE

Final products from CLC2000 project are taken as main input for building LEAC database. These products are delivered by country and they consist on three geographical layers:

- CORINE Land Cover 2000
- CORINE Land Cover 1990 revised
- Changes Database

These layers provide information on surface occupied by different types of Land Cover and the changes occurred in these surfaces between two dates (1990 – 2000).

The only territorial unit we can assign to these layers is the **country name** but we are interested on more geographic units and combinations of units:

- Administrative boundaries at various scales: NUTS3, NUTS2, NUTS1 and NUTS0
- Physical boundaries such as Watersheds, Sea Catchments, Biogeographic regions...

The first objective is to assign these **territorial units** to the CLC data. To do that, different kind of spatial information was integrated through a **Reference Grid** into a single database. The use of a standard reference grid as minimum territorial unit will allow further integration of socioeconomic and field sampling data. The use of classic database management systems will facilitate the analysis and dissemination of the information.

Integration of the Land Cover data and Territorial Units into a Database through a Reference Grid. The use of the Reference Grid is a key point on the integration of the information as it allows easy updating and combining Territorial Units.

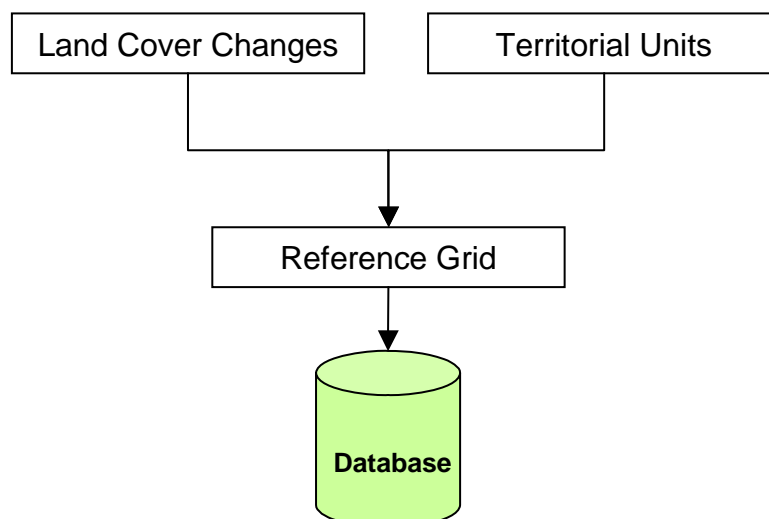

2.1.1. Creation of the Reference Grid

The use of standard grids has been recognised as key point for the integration of heterogeneous sources of data. The standard codification of grid cells makes them suitable for splitting the territory into a number of regular pieces that can be used as analysis units.

A 1km x 1km paneuropean grid was created following the recommendations drafted in the proceedings of the 1ST Workshop on European Reference Grids. The process is done using a modified version of the Generate Fishnet Tool for ArcMap (Robert Nichola's). This customized tool, named "EEA Reference Grid Fishnet Tool for ArcGIS 9" can be downloaded from EIONET web page (<http://www.eionet.eu.int/gis>). It creates fishnet grids accordingly to the new European Standards

To reduce the number of cells, polygons intersecting with land cover data were selected (see the coloured surface in the figure below).

After integrating Land Cover data and Territorial units attributes the information is held for each of the more than 4500000 grid squares that make up the CLC coverage and stored in a database.

An optimised database structure can be defined depending on the use given to the data. In the following pages we describe the process of integrating information into the Reference grid as well as the data structure resulting from this process.

Study area (red square) covering the current and potential CLC extent. Canary Islands (Spain) in the southwestern corner and Norway and Turkey as northern and eastern limits respectively. Colors for countries indicate the availability of CLC90 revised [Green: available, Orange: not available]. Both green and orange countries have also delivered the Change Database.

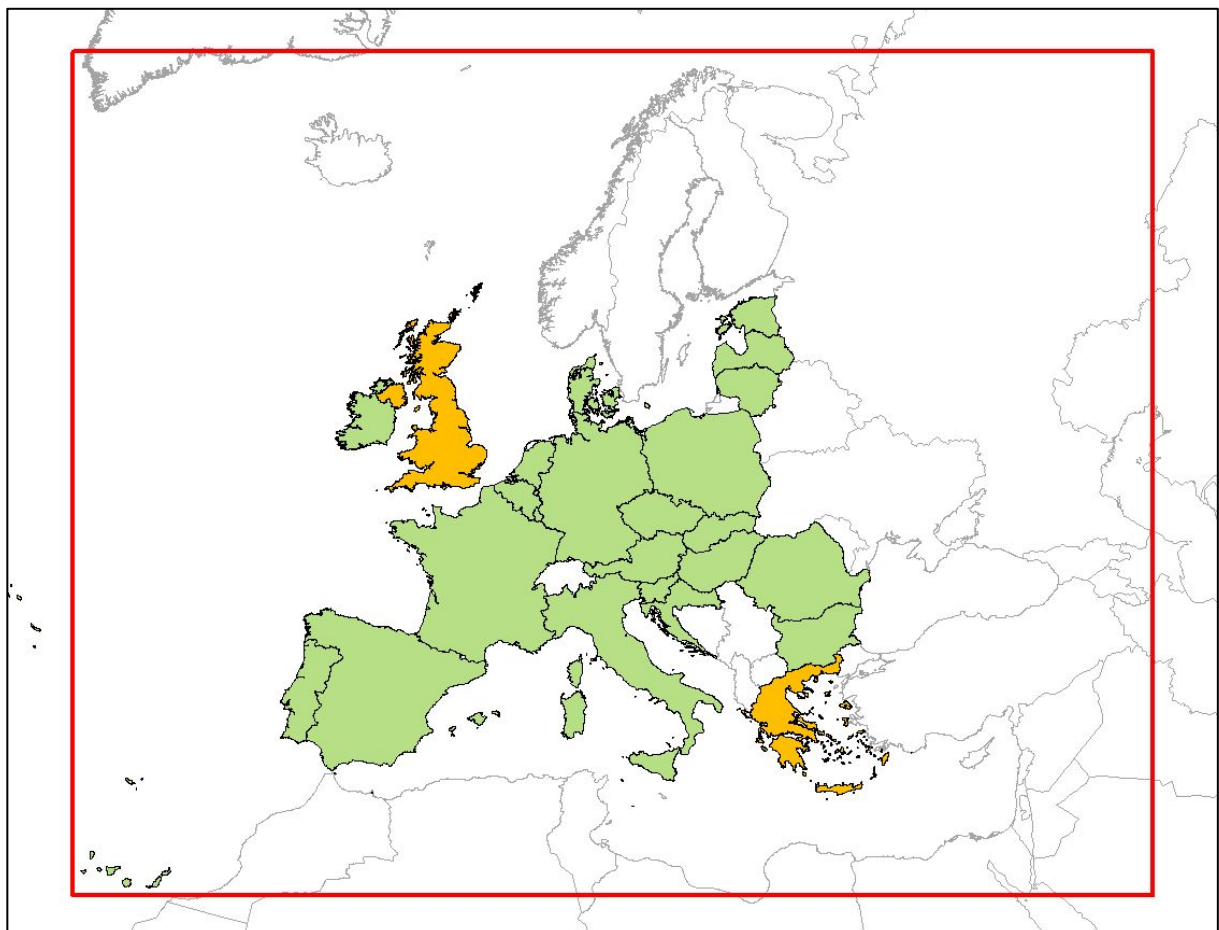

2.1.2. Integration of Land Cover Change data

The preparation of Land Cover Change data is the prior step to the integration into the Reference Grid. Due to the variety of products (vector and rasters at various resolutions) several approaches to Land Cover Change can be used to report Land Cover accounts. Differences between these approaches are being analysed by the ETCTE.

The standard source information is the **Change Database** but some preparation is needed to build a coherent database. Combining **Land Cover Codes** from initial year and final year layers creates a **Change Code**. For example, a change from coniferous forest (311) to continuous urban fabric (111) will be coded as 311111. The classification and nomenclature for these new codes are detailed in the next chapter "2.2 Changes classification: Land Cover flows".

Depending on the format of the data (raster or vector) different procedures can be used (tabulating or intersecting) to obtain the same result: a table containing the total surface for each type of change in each grid cell of the reference grid.

This table called "LEAC_DATA" will contain three fields with the following information:

- Grid Cell Code
- Change Code
- Area (in hectares)

Change Database is a discontinuous layer that has to be filled with "no change" data coming from the CLC00 layer. Another change layer (under evaluation) was created combining CLC90 revised with CLC00. Both options will produce a continuous polygon layer with a 6 character **Change Code** that will be intersected with the reference grid.

Creating the Changes Table from Land Cover layers. The Change Code is the combination of the Land Cover Code for the initial year with the Land Cover Code for the final year. The example below shows the process for a single cell (K1000E3968N3163) and using the CLC raster data (100 m resolution). The change is marked with a red arrow.

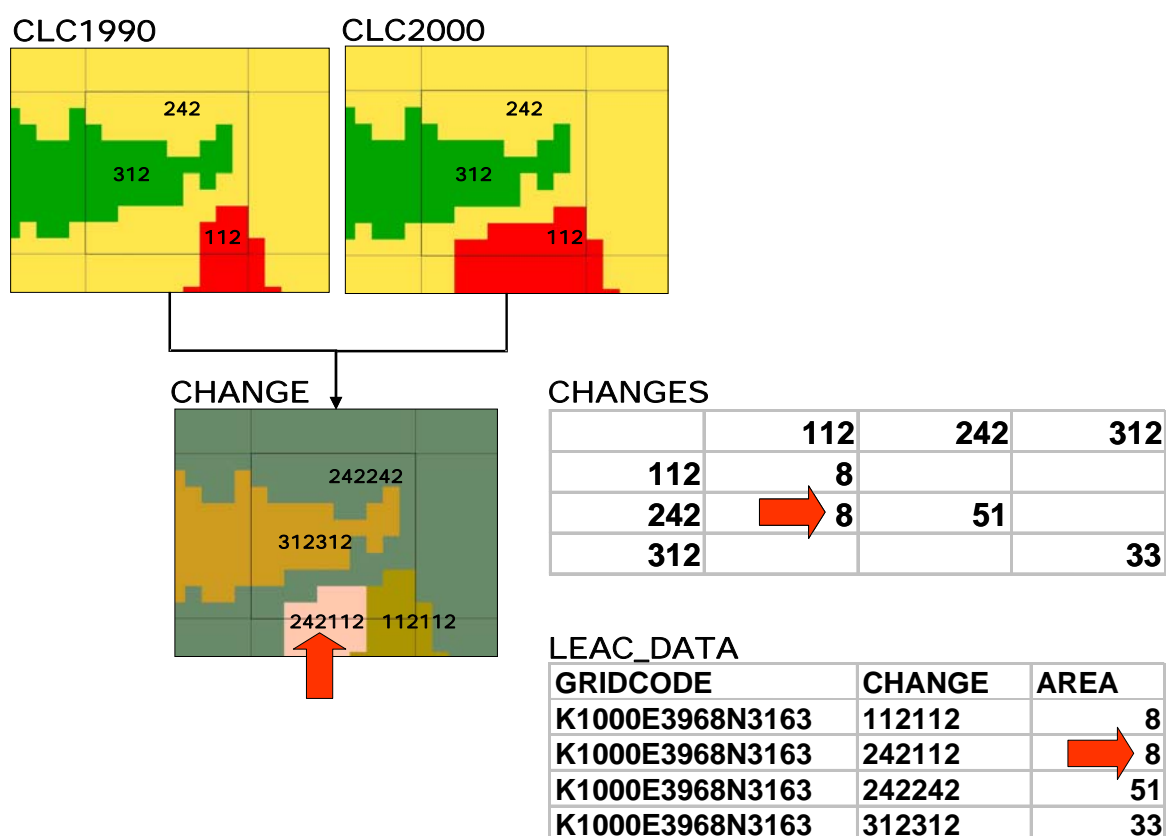

2.1.3. Integration of Territorial Units

Once Land Cover data is allocated to reference grid cells these cells need to be assigned to specific territorial units. These territorial units will be used to group the cells when analysing the land cover changes. At the same time some of these territorial units will be used to report the results of those analyses. In the context of LEAC we refer to these territorial units as **LARU** (Land Analytical and Reporting Unit)

Each cell holds a unique value for a given LARU. To assign a LARU value to a cell the "Maximum area" criterion is used, a standard method in most of rasterization processes. In this step some borders are generalizing but we assume this generalization in benefit of other advantages derived of using this system (Figure 3).

Due to geometric shifts between Land Cover layers and thematic layers (LARU) some of the coastal cells fall in "No Data" areas. To minimize this error we create proximity surfaces of the LARU attributes before assigning these values to the grid cells. The proximity surface is a kind of interpolation that assumes that a point with unknown value will get the new value from the closest point with known value (Figure 3).

Each LARU is stored in a field of a table that can be linked to the LEAC_DATA table through the Grid Cell Code. In the next point "2.1.4 Database structure" there is more information about table contents and relationships.

Steps followed to assign LARU values to the Reference Cells. A) To avoid cells with no data in coastal zones we derive proximity surfaces (using Thiessen Poligons). This way we fill coastal gaps with interpolated values that will minimize the error produced by the geometric shifts. **B)** Only one LARU value is assigned to each grid cell using a "Maximum area" criterion. This process produces a generalization of borders but it allows to update LARU values easily.

A) Attribute interpolation (proximity surface)

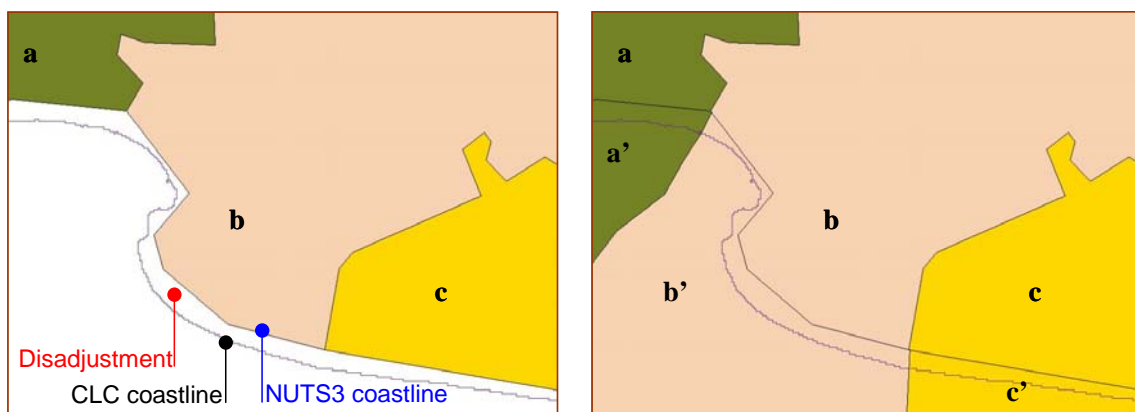

B) Attribute assignment (rasterization to 1 km)

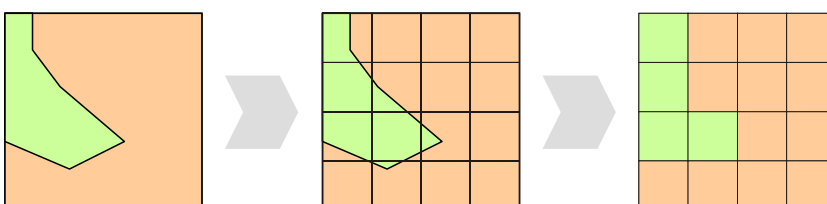

2.1.4. Database structure

Land Cover Changes data is translated to a Database System where the **Land Analytical and Reporting units (LARU)** can be easily updated. Information is held for each of the 1km x 1km grid squares that make up the CLC coverage. The **Grid Cell Code** acts as key field by linking **LEAC_DATA** and **LARU** tables. Statistics for **LARU** can be produced by selecting the grid squares that fall within them.

LEAC database is composed by two main tables and a set of definition tables. These main tables are:

- **LEAC_DATA:** contains land cover changes information for each reference grid cell. This table can be linked to LARU and FLATMATRIX tables which are used to analyse the land cover changes.
- **LARU:** contains the Land Analytical and Reporting Units codes for each grid cell.

In the following figures the relationships between tables are described as well as the field contents. Full data model for the LEAC database is shown in Annex A "LEAC Data Model".

Transforming spatial information to a classic entity-relationship structure has the purpose of simplifying the geoprocessing procedure. For example, combinations of Analytical Units such as Nuts3 by Dominant Landscape Type can be produced by running simple SQL queries into the database environment. This data structure is suitable to distribute this information using standard database formats and allowing users to perform spatial-based queries without GIS tools.

Relationship between the two main tables of LEAC database. LEAC_DATA contains the land cover information detailed as Change Code and Area. The Grid Cell Code (GRIDCODE) acts as key field linking with the **LARU** table that contains the codes for the Land Analytical and Reporting Units. This relationship is type **one to many** as the LEAC table contains various records for each reference grid cell.

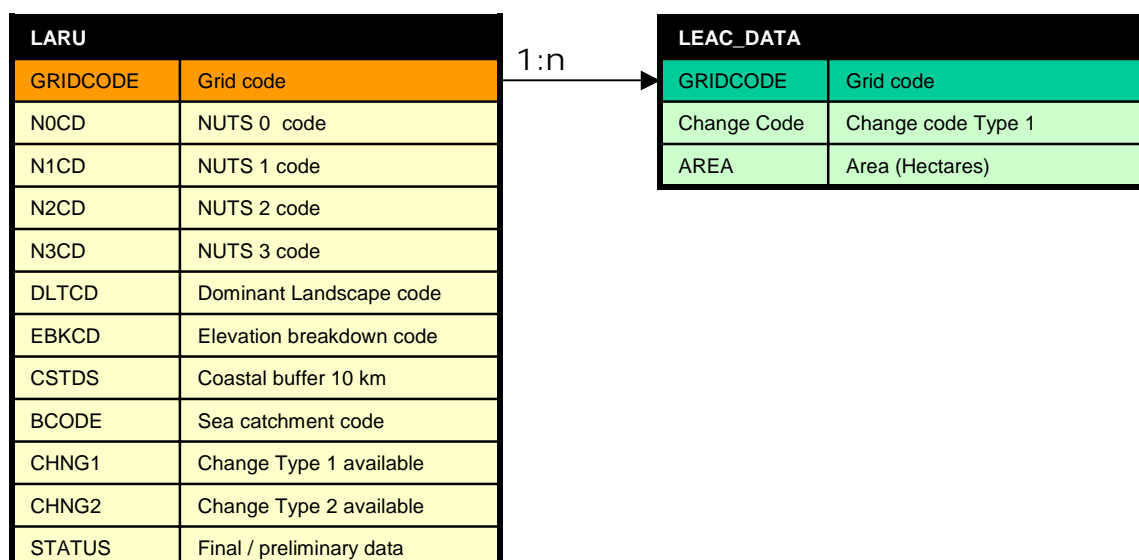

Land Analytical and Reporting Units (LARU) table and definition tables. LARU table stores the LARU values for each cell of the reference grid. The definitions of the LARU values are stored in separated tables that can be linked through the LARU code. The available LARU in the example are: Administrative units (various NUTS levels), Dominant Landscape Types, 10 Km coastal strip and Sea Catchment areas.

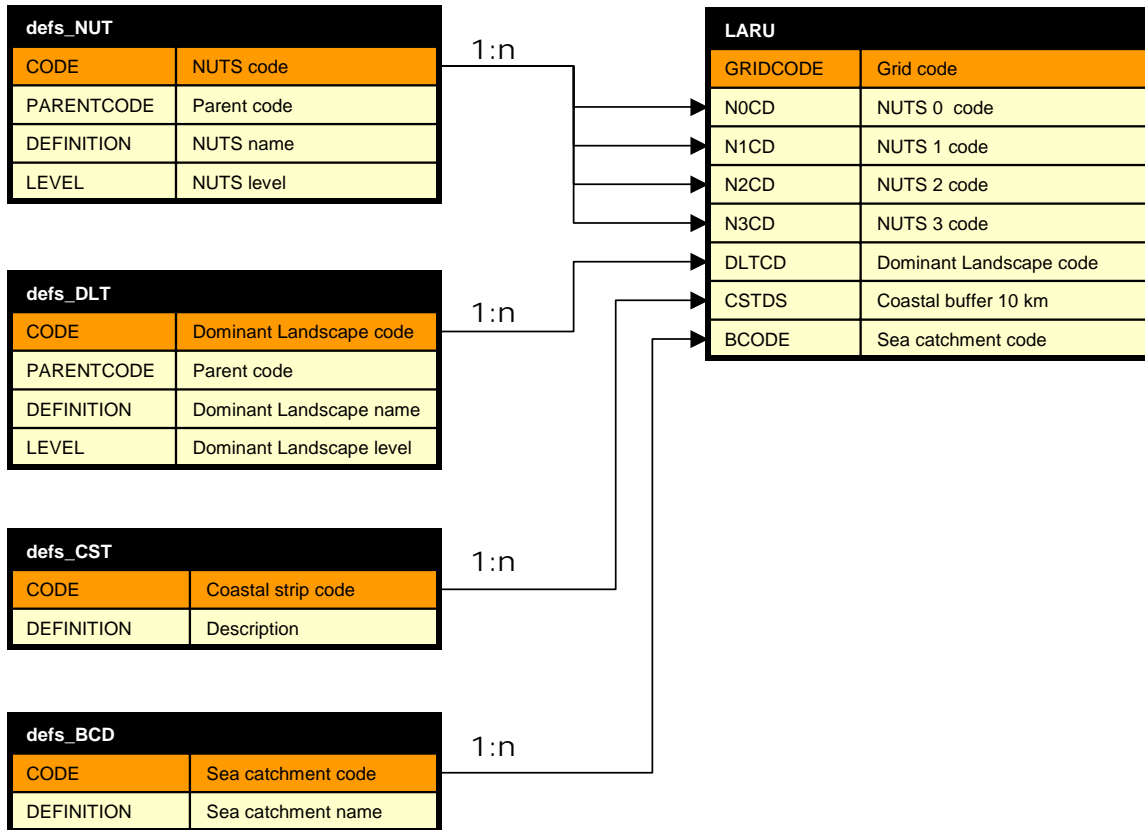

Definition of Land Cover Changes. The classification of Land Cover Changes into Land Cover Flows is detailed in the next chapter. The table FLATMATRIX contains the definitions for the various levels of Land Cover Flows and also the definitions of the CORINE classes for the initial and final years. This information can be linked to the LEAC_DATA table through the **Change Code** field.

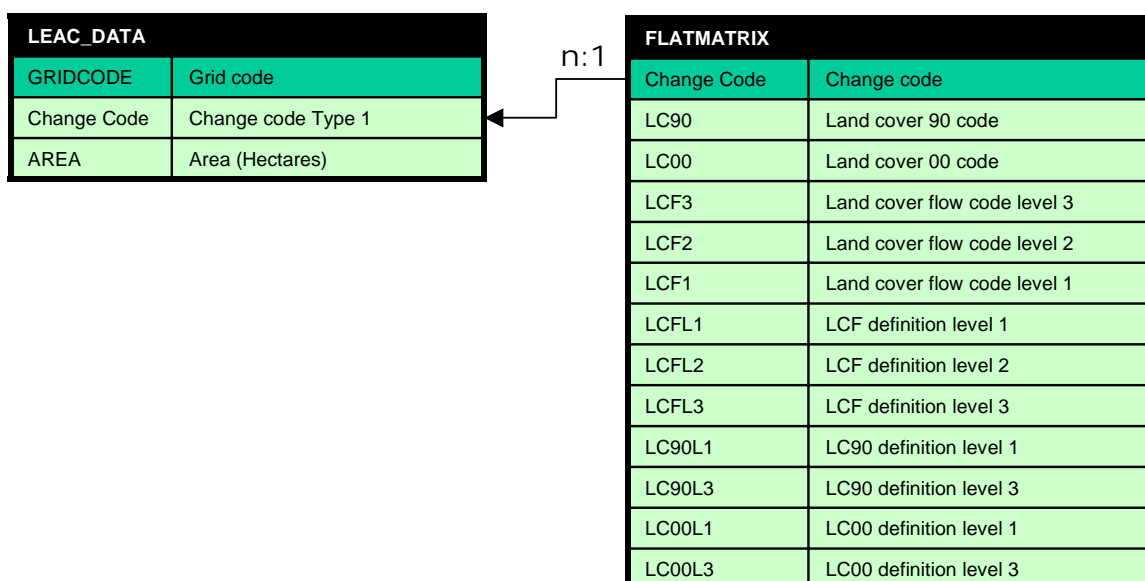

2.2. CHANGES CLASIFICATION: LAND COVER FLOWS

Land Cover Accounts summarize and interpret the $44 \times 43 = 1892$ possible one-to-one changes between the 44 CORINE land cover classes. The changes are grouped to so-called **flows of land cover** and are classified according to major land use processes:

- lcf1 Urban land management
- lcf2 Urban residential sprawl
- lcf3 Sprawl of economic sites and infrastructures
- lcf4 Agriculture internal conversions
- lcf5 Conversion from forested & natural land to agriculture
- lcf6 Withdrawal of farming
- lcf7 Forests creation and management
- lcf8 Water bodies creation and management
- lcf9 Changes of Land Cover due to natural and multiple causes

The nomenclature of flows is organized on 3 levels. Flows are described in Annex 1.

The classification of land cover flows results from the feasibility studies and subsequent revisions after discussion with experts in agri-environment and forestry. Basically, the classification of land cover flows distinguishes change between broad land cover classes and changes internal to these classes. Analysis of land cover flows supplies a rapid vision of processes taking place.

In the LEAC database the Land Cover Flows are described in the FLATMATRIX table. This table can be modified according to new revisions of the nomenclature or aggregation. The changes on this table will affect the final results

Combination of two Land Cover Layers to produce a Change Database. In the case of CORINE land cover (44 classes) the intersection between two layers produces 1936 possible combinations. 1892 are classified as changes and 44 are classified as "No change". To interpret this amount of information, Land Cover Changes are classified according to major Land Use processes into about 50 Land Cover Flows.

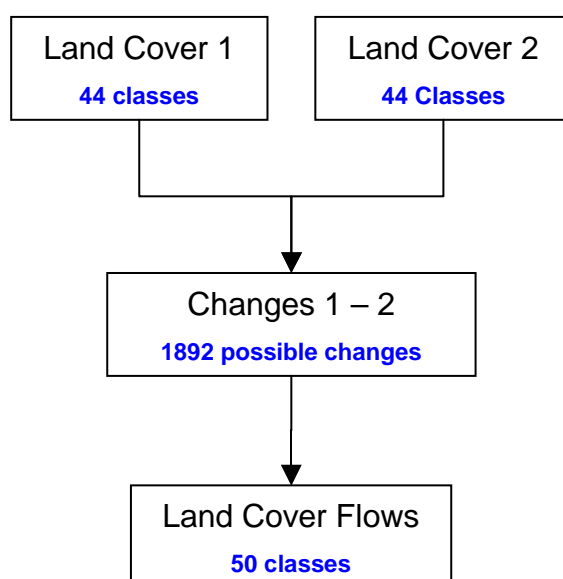

Land Cover Flows hierarchy. Classification of Land Cover Changes Matrix into Land Cover Flows can be done in three levels of aggregation. An example of level hierarchy is shown below. Colors in the figure show the Level 1 classification. Go to the Annex 1 and 2 for a complete description of Land Cover Flow classification.

LCF4 Agriculture internal conversions



LCF41 Extension of set aside fallow land and pasture



LCF411 Uniform extension of set aside fallow land and pasture

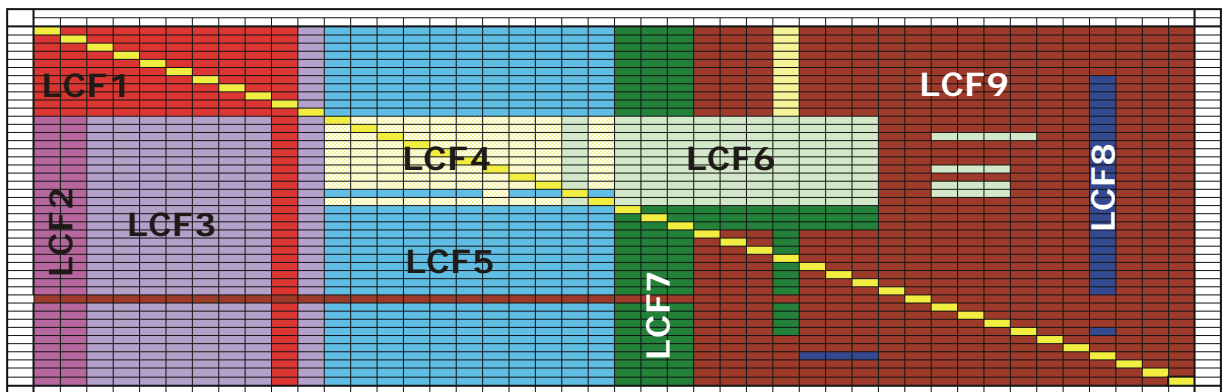

ANNEX 1: MATRIX OF LAND COVER FLOWS

Part a – Formation of Artificial surfaces

		111	112	121	122	123	124	131	132	133	141	142
		Continuous urban fabric	Discontinuous urban fabric	Industrial or commercial units	Road and rail networks and associated land	Port areas	Airports	Mineral extraction sites	Dump sites	Construction sites	Green urban areas	Sport and leisure facilities
111	Continuous urban fabric		lcf12	lcf12	lcf12	lcf12	lcf12	lcf12	lcf12	lcf12	lcf13	lcf38
112	Discontinuous urban fabric	lcf11		lcf11	lcf11	lcf11	lcf11	lcf11	lcf11	lcf11	lcf13	lcf38
121	Industrial or commercial units	lcf12	lcf12		lcf12	lcf12	lcf12	lcf12	lcf12	lcf12	lcf13	lcf38
122	Road and rail networks and associated land	lcf12	lcf12	lcf12		lcf12	lcf12	lcf12	lcf12	lcf12	lcf13	lcf38
123	Port areas	lcf12	lcf12	lcf12	lcf12		lcf12	lcf12	lcf12	lcf12	lcf13	lcf38
124	Airports	lcf12	lcf12	lcf12	lcf12	lcf12		lcf12	lcf12	lcf12	lcf13	lcf38
131	Mineral extraction sites	lcf12	lcf12	lcf12	lcf12	lcf12	lcf12		lcf12	lcf12	lcf13	lcf38
132	Dump sites	lcf12	lcf12	lcf12	lcf12	lcf12	lcf12	lcf12		lcf12	lcf13	lcf38
133	Construction sites	lcf12	lcf12	lcf12	lcf12	lcf12	lcf12	lcf12	lcf12		lcf13	lcf38
141	Green urban areas	lcf11	lcf11	lcf11	lcf11	lcf11	lcf11	lcf11	lcf11	lcf11		lcf38
142	Sport and leisure facilities	lcf11	lcf11	lcf11	lcf11	lcf11	lcf11	lcf11	lcf11	lcf11	lcf13	
211	Non-irrigated arable land	lcf21	lcf22	lcf31	lcf32	lcf33	lcf34	lcf35	lcf36	lcf37	lcf13	lcf38
212	Permanently irrigated land	lcf21	lcf22	lcf31	lcf32	lcf33	lcf34	lcf35	lcf36	lcf37	lcf13	lcf38
213	Rice fields	lcf21	lcf22	lcf31	lcf32	lcf33	lcf34	lcf35	lcf36	lcf37	lcf13	lcf38
221	Vineyards	lcf21	lcf22	lcf31	lcf32	lcf33	lcf34	lcf35	lcf36	lcf37	lcf13	lcf38
222	Fruit trees and berry plantations	lcf21	lcf22	lcf31	lcf32	lcf33	lcf34	lcf35	lcf36	lcf37	lcf13	lcf38
223	Olive groves	lcf21	lcf22	lcf31	lcf32	lcf33	lcf34	lcf35	lcf36	lcf37	lcf13	lcf38
231	Pastures	lcf21	lcf22	lcf31	lcf32	lcf33	lcf34	lcf35	lcf36	lcf37	lcf13	lcf38
241	Annual crops associated with permanent crops	lcf21	lcf22	lcf31	lcf32	lcf33	lcf34	lcf35	lcf36	lcf37	lcf13	lcf38
242	Complex cultivation patterns	lcf21	lcf22	lcf31	lcf32	lcf33	lcf34	lcf35	lcf36	lcf37	lcf13	lcf38
243	Land principally occupied by agriculture with significant areas of natural vegetation	lcf21	lcf22	lcf31	lcf32	lcf33	lcf34	lcf35	lcf36	lcf37	lcf13	lcf38
244	Agro-forestry areas	lcf21	lcf22	lcf31	lcf32	lcf33	lcf34	lcf35	lcf36	lcf37	lcf13	lcf38
311	Broad-leaved forest	lcf21	lcf22	lcf31	lcf32	lcf33	lcf34	lcf35	lcf36	lcf37	lcf13	lcf38
312	Coniferous forest	lcf21	lcf22	lcf31	lcf32	lcf33	lcf34	lcf35	lcf36	lcf37	lcf13	lcf38
313	Mixed forest	lcf21	lcf22	lcf31	lcf32	lcf33	lcf34	lcf35	lcf36	lcf37	lcf13	lcf38
321	Natural grassland	lcf21	lcf22	lcf31	lcf32	lcf33	lcf34	lcf35	lcf36	lcf37	lcf13	lcf38
322	Moors and heathland	lcf21	lcf22	lcf31	lcf32	lcf33	lcf34	lcf35	lcf36	lcf37	lcf13	lcf38
323	Sclerophyllous vegetation	lcf21	lcf22	lcf31	lcf32	lcf33	lcf34	lcf35	lcf36	lcf37	lcf13	lcf38
324	Transitional woodland shrub	lcf21	lcf22	lcf31	lcf32	lcf33	lcf34	lcf35	lcf36	lcf37	lcf13	lcf38
331	Beaches, dunes and sand plains	lcf21	lcf22	lcf31	lcf32	lcf33	lcf34	lcf35	lcf36	lcf37	lcf13	lcf38
332	Bare rock	lcf21	lcf22	lcf31	lcf32	lcf33	lcf34	lcf35	lcf36	lcf37	lcf13	lcf38
333	Sparsely vegetated areas	lcf21	lcf22	lcf31	lcf32	lcf33	lcf34	lcf35	lcf36	lcf37	lcf13	lcf38
334	Burnt areas	lcf21	lcf22	lcf31	lcf32	lcf33	lcf34	lcf35	lcf36	lcf37	lcf13	lcf38
335	Glaciers and perpetual snow	lcf99	lcf99	lcf99	lcf99	lcf99	lcf99	lcf99	lcf99	lcf99	lcf99	lcf99
411	Inland marshes	lcf21	lcf22	lcf31	lcf32	lcf33	lcf34	lcf35	lcf36	lcf37	lcf13	lcf38
412	Peatbogs	lcf21	lcf22	lcf31	lcf32	lcf33	lcf34	lcf35	lcf36	lcf37	lcf13	lcf38
421	Salt marshes	lcf21	lcf22	lcf31	lcf32	lcf33	lcf34	lcf35	lcf36	lcf37	lcf13	lcf38
422	Salines	lcf21	lcf22	lcf31	lcf32	lcf33	lcf34	lcf35	lcf36	lcf37	lcf13	lcf38
423	Intertidal flats	lcf21	lcf22	lcf31	lcf32	lcf33	lcf34	lcf35	lcf36	lcf37	lcf13	lcf38
511	Water courses	lcf21	lcf22	lcf31	lcf32	lcf33	lcf34	lcf35	lcf36	lcf37	lcf13	lcf38
512	Water bodies	lcf21	lcf22	lcf31	lcf32	lcf33	lcf34	lcf35	lcf36	lcf37	lcf13	lcf38
521	Coastal lagoons	lcf21	lcf22	lcf31	lcf32	lcf33	lcf34	lcf35	lcf36	lcf37	lcf13	lcf38
522	Estuaries	lcf21	lcf22	lcf31	lcf32	lcf33	lcf34	lcf35	lcf36	lcf37	lcf13	lcf38
523	Sea and ocean	lcf21	lcf22	lcf31	lcf32	lcf33	lcf34	lcf35	lcf36	lcf37	lcf13	lcf38

Part b – Formation of Agricultural areas

		211	212	213	221	222	223	231	241	242	243	244
		Non-irrigated arable land	Permanently irrigated land	Rice fields	Vineyards	Fruit trees and berry plantations	Olive groves	Pastures	Annual crops associated with permanent crops	Complex cultivation patterns	Land principally occupied by agriculture with significant areas of natural vegetation	Agro-forestry areas
111	Continuous urban fabric	lcf54	lcf54	lcf54	lcf54	lcf54	lcf54	lcf54	lcf54	lcf54	lcf54	lcf54
112	Discontinuous urban fabric	lcf54	lcf54	lcf54	lcf54	lcf54	lcf54	lcf54	lcf54	lcf54	lcf54	lcf54
121	Industrial or commercial units	lcf54	lcf54	lcf54	lcf54	lcf54	lcf54	lcf54	lcf54	lcf54	lcf54	lcf54
122	Road and rail networks and associated land	lcf54	lcf54	lcf54	lcf54	lcf54	lcf54	lcf54	lcf54	lcf54	lcf54	lcf54
123	Port areas	lcf54	lcf54	lcf54	lcf54	lcf54	lcf54	lcf54	lcf54	lcf54	lcf54	lcf54
124	Airports	lcf54	lcf54	lcf54	lcf54	lcf54	lcf54	lcf54	lcf54	lcf54	lcf54	lcf54
131	Mineral extraction sites	lcf54	lcf54	lcf54	lcf54	lcf54	lcf54	lcf54	lcf54	lcf54	lcf54	lcf54
132	Dump sites	lcf54	lcf54	lcf54	lcf54	lcf54	lcf54	lcf54	lcf54	lcf54	lcf54	lcf54
133	Construction sites	lcf54	lcf54	lcf54	lcf54	lcf54	lcf54	lcf54	lcf54	lcf54	lcf54	lcf54
141	Green urban areas	lcf54	lcf54	lcf54	lcf54	lcf54	lcf54	lcf54	lcf54	lcf54	lcf54	lcf54
142	Sport and leisure facilities	lcf54	lcf54	lcf54	lcf54	lcf54	lcf54	lcf54	lcf54	lcf54	lcf54	lcf54
211	Non-irrigated arable land	lcf422	lcf421	lcf421	lcf451	lcf451	lcf452	lcf411	lcf453	lcf412	lcf62	lcf47
212	Permanently irrigated land	lcf422	lcf422	lcf422	lcf451	lcf451	lcf452	lcf411	lcf453	lcf412	lcf62	lcf47
213	Rice fields	lcf422	lcf422	lcf422	lcf451	lcf451	lcf452	lcf411	lcf453	lcf412	lcf62	lcf47
221	Vineyards	lcf442	lcf441	lcf441	lcf441	lcf433	lcf432	lcf411	lcf444	lcf444	lcf62	lcf47
222	Fruit trees and berry plantations	lcf442	lcf441	lcf441	lcf433	lcf433	lcf432	lcf411	lcf444	lcf444	lcf62	lcf47
223	Olive groves	lcf443	lcf441	lcf441	lcf431	lcf431	lcf431	lcf411	lcf443	lcf443	lcf62	lcf47
231	Pastures	lcf462	lcf461	lcf461	lcf462	lcf462	lcf462	lcf411	lcf462	lcf463	lcf62	lcf47
241	Annual crops associated with permanent crops	lcf442	lcf441	lcf441	lcf451	lcf451	lcf452	lcf411	lcf411	lcf412	lcf62	lcf47
242	Complex cultivation patterns	lcf463	lcf463	lcf463	lcf463	lcf463	lcf463	lcf412	lcf463	lcf412	lcf62	lcf47
243	Land principally occupied by agriculture with significant areas of natural vegetation	lcf521	lcf521	lcf521	lcf521	lcf521	lcf521	lcf412	lcf521	lcf522	lcf522	lcf522
244	Agro-forestry areas	lcf462	lcf461	lcf461	lcf462	lcf462	lcf462	lcf412	lcf462	lcf463	lcf62	lcf47
311	Broad-leaved forest	lcf511	lcf511	lcf511	lcf511	lcf511	lcf511	lcf512	lcf511	lcf512	lcf512	lcf512
312	Coniferous forest	lcf511	lcf511	lcf511	lcf511	lcf511	lcf511	lcf512	lcf511	lcf512	lcf512	lcf512
313	Mixed forest	lcf511	lcf511	lcf511	lcf511	lcf511	lcf511	lcf512	lcf511	lcf512	lcf512	lcf512
321	Natural grassland	lcf521	lcf521	lcf521	lcf521	lcf521	lcf521	lcf522	lcf521	lcf522	lcf522	lcf522
322	Moors and heathland	lcf521	lcf521	lcf521	lcf521	lcf521	lcf521	lcf522	lcf521	lcf522	lcf522	lcf522
323	Sclerophyllous vegetation	lcf521	lcf521	lcf521	lcf521	lcf521	lcf521	lcf522	lcf521	lcf522	lcf522	lcf522
324	Transitional woodland shrub	lcf511	lcf511	lcf511	lcf511	lcf511	lcf511	lcf512	lcf511	lcf512	lcf512	lcf512
331	Beaches, dunes and sand plains	lcf521	lcf521	lcf521	lcf521	lcf521	lcf521	lcf522	lcf521	lcf522	lcf522	lcf522
332	Bare rock	lcf521	lcf521	lcf521	lcf521	lcf521	lcf521	lcf522	lcf521	lcf522	lcf522	lcf522
333	Sparsely vegetated areas	lcf521	lcf521	lcf521	lcf521	lcf521	lcf521	lcf522	lcf521	lcf522	lcf522	lcf522
334	Burnt areas	lcf521	lcf521	lcf521	lcf521	lcf521	lcf521	lcf522	lcf521	lcf522	lcf522	lcf522
335	Glaciers and perpetual snow	lcf99	lcf99	lcf99	lcf99	lcf99	lcf99	lcf99	lcf99	lcf99	lcf99	lcf99
411	Inland marshes	lcf53	lcf53	lcf53	lcf53	lcf53	lcf53	lcf53	lcf53	lcf53	lcf53	lcf53
412	Peatbogs	lcf53	lcf53	lcf53	lcf53	lcf53	lcf53	lcf53	lcf53	lcf53	lcf53	lcf53
421	Salt marshes	lcf53	lcf53	lcf53	lcf53	lcf53	lcf53	lcf53	lcf53	lcf53	lcf53	lcf53
422	Salines	lcf53	lcf53	lcf53	lcf53	lcf53	lcf53	lcf53	lcf53	lcf53	lcf53	lcf53
423	Intertidal flats	lcf53	lcf53	lcf53	lcf53	lcf53	lcf53	lcf53	lcf53	lcf53	lcf53	lcf53
511	Water courses	lcf53	lcf53	lcf53	lcf53	lcf53	lcf53	lcf53	lcf53	lcf53	lcf53	lcf53

Part c – Formation of Forested or open natural surfaces

	311	312	313	321	322	323	324	331	332	333	334	335	
	Broad-leaved forest	Coniferous forest	Mixed forest	Natural grassland	Moors and heathland	Sclerophyllous vegetation	Transitional woodland shrub	Beaches, dunes and sand plains	Bare rock	Sparsely vegetated areas	Burnt areas	Glaciers and perpetual snow	
111	Continuous urban fabric	lcf72	lcf72	lcf72	lcf911	lcf911	lcf911	lcf72	lcf911	lcf911	lcf911	lcf92	lcf99
112	Discontinuous urban fabric	lcf72	lcf72	lcf72	lcf911	lcf911	lcf911	lcf72	lcf911	lcf911	lcf911	lcf92	lcf99
121	Industrial or commercial units	lcf72	lcf72	lcf72	lcf911	lcf911	lcf911	lcf72	lcf911	lcf911	lcf911	lcf92	lcf99
122	Road and rail networks and associated land	lcf72	lcf72	lcf72	lcf911	lcf911	lcf911	lcf72	lcf911	lcf911	lcf911	lcf92	lcf99
123	Port areas	lcf72	lcf72	lcf72	lcf911	lcf911	lcf911	lcf72	lcf911	lcf911	lcf911	lcf92	lcf99
124	Airports	lcf72	lcf72	lcf72	lcf911	lcf911	lcf911	lcf72	lcf911	lcf911	lcf911	lcf92	lcf99
131	Mineral extraction sites	lcf72	lcf72	lcf72	lcf911	lcf911	lcf911	lcf72	lcf911	lcf911	lcf911	lcf92	lcf99
132	Dump sites	lcf72	lcf72	lcf72	lcf911	lcf911	lcf911	lcf72	lcf911	lcf911	lcf911	lcf92	lcf99
133	Construction sites	lcf72	lcf72	lcf72	lcf911	lcf911	lcf911	lcf72	lcf911	lcf911	lcf911	lcf92	lcf99
141	Green urban areas	lcf72	lcf72	lcf72	lcf911	lcf911	lcf911	lcf72	lcf911	lcf911	lcf911	lcf92	lcf99
142	Sport and leisure facilities	lcf72	lcf72	lcf72	lcf911	lcf911	lcf911	lcf72	lcf911	lcf911	lcf911	lcf92	lcf99
211	Non-irrigated arable land	lcf61	lcf61	lcf61	lcf62	lcf62	lcf62	lcf61	lcf62	lcf62	lcf62	lcf92	lcf99
212	Permanently irrigated land	lcf61	lcf61	lcf61	lcf62	lcf62	lcf62	lcf61	lcf62	lcf62	lcf62	lcf92	lcf99
213	Rice fields	lcf61	lcf61	lcf61	lcf62	lcf62	lcf62	lcf61	lcf62	lcf62	lcf62	lcf92	lcf99
221	Vineyards	lcf61	lcf61	lcf61	lcf62	lcf62	lcf62	lcf61	lcf62	lcf62	lcf62	lcf92	lcf99
222	Fruit trees and berry plantations	lcf61	lcf61	lcf61	lcf62	lcf62	lcf62	lcf61	lcf62	lcf62	lcf62	lcf92	lcf99
223	Olive groves	lcf61	lcf61	lcf61	lcf62	lcf62	lcf62	lcf61	lcf62	lcf62	lcf62	lcf92	lcf99
231	Pastures	lcf61	lcf61	lcf61	lcf62	lcf62	lcf62	lcf61	lcf62	lcf62	lcf62	lcf92	lcf99
241	Annual crops associated with permanent crops	lcf61	lcf61	lcf61	lcf62	lcf62	lcf62	lcf61	lcf62	lcf62	lcf62	lcf92	lcf99
242	Complex cultivation patterns	lcf61	lcf61	lcf61	lcf62	lcf62	lcf62	lcf61	lcf62	lcf62	lcf62	lcf92	lcf99
243	Land principally occupied by agriculture with significant areas of natural vegetation	lcf61	lcf61	lcf61	lcf62	lcf62	lcf62	lcf61	lcf62	lcf62	lcf62	lcf92	lcf99
244	Agro-forestry areas	lcf61	lcf61	lcf61	lcf62	lcf62	lcf62	lcf61	lcf62	lcf62	lcf62	lcf92	lcf99
311	Broad-leaved forest	lcf73	lcf73	lcf73	lcf74	lcf74	lcf74	lcf74	lcf74	lcf74	lcf74	lcf92	lcf99
312	Coniferous forest	lcf73	lcf73	lcf73	lcf74	lcf74	lcf74	lcf74	lcf74	lcf74	lcf74	lcf92	lcf99
313	Mixed forest	lcf73	lcf73	lcf73	lcf74	lcf74	lcf74	lcf74	lcf74	lcf74	lcf74	lcf92	lcf99
321	Natural grassland	lcf72	lcf72	lcf72	lcf912	lcf912	lcf912	lcf72	lcf912	lcf912	lcf912	lcf92	lcf99
322	Moors and heathland	lcf72	lcf72	lcf72	lcf912	lcf912	lcf912	lcf72	lcf912	lcf912	lcf912	lcf92	lcf99
323	Sclerophyllous vegetation	lcf72	lcf72	lcf72	lcf912	lcf912	lcf912	lcf72	lcf912	lcf912	lcf912	lcf92	lcf99
324	Transitional woodland shrub	lcf71	lcf71	lcf71	lcf911	lcf911	lcf911	lcf911	lcf911	lcf911	lcf911	lcf92	lcf99
331	Beaches, dunes and sand plains	lcf72	lcf72	lcf72	lcf912	lcf912	lcf912	lcf72	lcf912	lcf912	lcf912	lcf92	lcf99
332	Bare rock	lcf72	lcf72	lcf72	lcf912	lcf912	lcf912	lcf72	lcf912	lcf912	lcf912	lcf92	lcf912
333	Sparsely vegetated areas	lcf72	lcf72	lcf72	lcf912	lcf912	lcf912	lcf72	lcf912	lcf912	lcf912	lcf92	lcf912
334	Burnt areas	lcf72	lcf72	lcf72	lcf912	lcf912	lcf912	lcf72	lcf912	lcf912	lcf912	lcf92	lcf99
335	Glaciers and perpetual snow	lcf99	lcf99	lcf99	lcf94	lcf94	lcf94	lcf94	lcf94	lcf94	lcf94	lcf99	lcf99
411	Inland marshes	lcf72	lcf72	lcf72	lcf912	lcf912	lcf912	lcf72	lcf912	lcf912	lcf912	lcf99	lcf99
412	Peatbogs	lcf72	lcf72	lcf72	lcf912	lcf912	lcf912	lcf72	lcf912	lcf912	lcf912	lcf92	lcf99
421	Salt marshes	lcf72	lcf72	lcf72	lcf912	lcf912	lcf912	lcf72	lcf912	lcf912	lcf912	lcf99	lcf99
422	Salines	lcf72	lcf72	lcf72	lcf911	lcf911	lcf911	lcf72	lcf911	lcf911	lcf911	lcf99	lcf99
423	Intertidal flats	lcf72	lcf72	lcf72	lcf99	lcf99	lcf99	lcf99	lcf99	lcf93	lcf99	lcf99	lcf99
511	Water courses	lcf72	lcf72	lcf72	lcf99	lcf99	lcf99	lcf99	lcf99	lcf99	lcf99	lcf99	lcf99
512	Water bodies	lcf72	lcf72	lcf72	lcf99	lcf99	lcf99	lcf99	lcf82	lcf82	lcf82	lcf99	lcf99
521	Coastal lagoons	lcf72	lcf72	lcf72	lcf99	lcf99	lcf99	lcf99	lcf99	lcf99	lcf99	lcf99	lcf99
522	Estuaries	lcf72	lcf72	lcf72	lcf99	lcf99	lcf99	lcf99	lcf99	lcf99	lcf99	lcf99	lcf99
523	Sea and ocean	lcf72	lcf72	lcf72	lcf99	lcf99	lcf99	lcf99	lcf99	lcf99	lcf99	lcf99	lcf99

Part d – Formation of Wetlands and Water surfaces

		411	412	421	422	423	511	512	521	522	523
		Inland marshes	Peatbogs	Salt marshes	Salines	Intertidal flats	Water courses	Water bodies	Coastal lagoons	Estuaries	Sea and ocean
111	Continuous urban fabric	lcf99	lcf99	lcf99	lcf99	lcf93	lcf913	lcf99	lcf99	lcf93	lcf93
112	Discontinuous urban fabric	lcf99	lcf99	lcf99	lcf99	lcf93	lcf913	lcf99	lcf99	lcf93	lcf93
121	Industrial or commercial units	lcf99	lcf99	lcf99	lcf99	lcf93	lcf913	lcf99	lcf99	lcf93	lcf93
122	Road and rail networks and associated land	lcf99	lcf99	lcf99	lcf99	lcf93	lcf913	lcf99	lcf99	lcf93	lcf93
123	Port areas	lcf99	lcf99	lcf99	lcf99	lcf93	lcf913	lcf99	lcf99	lcf93	lcf93
124	Airports	lcf99	lcf99	lcf99	lcf99	lcf93	lcf913	lcf99	lcf99	lcf93	lcf93
131	Mineral extraction sites	lcf99	lcf99	lcf99	lcf99	lcf93	lcf913	lcf81	lcf99	lcf93	lcf93
132	Dump sites	lcf99	lcf99	lcf99	lcf99	lcf93	lcf913	lcf81	lcf99	lcf93	lcf93
133	Construction sites	lcf99	lcf99	lcf99	lcf99	lcf93	lcf913	lcf81	lcf99	lcf93	lcf93
141	Green urban areas	lcf99	lcf99	lcf99	lcf99	lcf93	lcf913	lcf81	lcf99	lcf93	lcf93
142	Sport and leisure facilities	lcf99	lcf99	lcf99	lcf99	lcf93	lcf913	lcf81	lcf99	lcf93	lcf93
211	Non-irrigated arable land	lcf99	lcf99	lcf99	lcf99	lcf93	lcf913	lcf81	lcf99	lcf93	lcf93
212	Permanently irrigated land	lcf99	lcf99	lcf99	lcf99	lcf93	lcf913	lcf81	lcf99	lcf93	lcf93
213	Rice fields	lcf62	lcf62	lcf62	lcf62	lcf93	lcf913	lcf81	lcf62	lcf93	lcf93
221	Vineyards	lcf99	lcf99	lcf99	lcf99	lcf93	lcf913	lcf81	lcf99	lcf93	lcf93
222	Fruit trees and berry plantations	lcf99	lcf99	lcf99	lcf99	lcf93	lcf913	lcf81	lcf99	lcf93	lcf93
223	Olive groves	lcf99	lcf99	lcf99	lcf99	lcf93	lcf913	lcf81	lcf99	lcf93	lcf93
231	Pastures	lcf62	lcf62	lcf62	lcf99	lcf93	lcf913	lcf81	lcf99	lcf93	lcf93
241	Annual crops associated with permanent crops	lcf99	lcf99	lcf99	lcf99	lcf93	lcf913	lcf81	lcf99	lcf93	lcf93
242	Complex cultivation patterns	lcf62	lcf62	lcf62	lcf99	lcf93	lcf913	lcf81	lcf99	lcf93	lcf93
243	Land principally occupied by agriculture with significant areas of natural vegetation	lcf62	lcf62	lcf62	lcf99	lcf93	lcf913	lcf81	lcf99	lcf93	lcf93
244	Agro-forestry areas	lcf62	lcf99	lcf99	lcf99	lcf93	lcf913	lcf81	lcf99	lcf93	lcf93
311	Broad-leaved forest	lcf99	lcf99	lcf99	lcf99	lcf93	lcf913	lcf81	lcf99	lcf93	lcf93
312	Coniferous forest	lcf99	lcf99	lcf99	lcf99	lcf93	lcf913	lcf81	lcf99	lcf93	lcf93
313	Mixed forest	lcf99	lcf99	lcf99	lcf99	lcf93	lcf913	lcf81	lcf99	lcf93	lcf93
321	Natural grassland	lcf912	lcf912	lcf912	lcf99	lcf93	lcf913	lcf81	lcf99	lcf93	lcf93
322	Moors and heathland	lcf912	lcf912	lcf912	lcf99	lcf93	lcf913	lcf81	lcf99	lcf93	lcf93
323	Sclerophyllous vegetation	lcf912	lcf912	lcf912	lcf99	lcf93	lcf913	lcf81	lcf99	lcf93	lcf93
324	Transitional woodland shrub	lcf911	lcf911	lcf911	lcf99	lcf93	lcf913	lcf81	lcf99	lcf93	lcf93
331	Beaches, dunes and sand plains	lcf912	lcf912	lcf912	lcf99	lcf93	lcf913	lcf81	lcf99	lcf93	lcf93
332	Bare rock	lcf99	lcf99	lcf99	lcf99	lcf93	lcf913	lcf81	lcf99	lcf93	lcf93
333	Sparsely vegetated areas	lcf912	lcf912	lcf912	lcf99	lcf93	lcf913	lcf81	lcf99	lcf93	lcf93
334	Burnt areas	lcf912	lcf912	lcf912	lcf99	lcf93	lcf913	lcf81	lcf99	lcf93	lcf93
335	Glaciers and perpetual snow	lcf94	lcf94	lcf94	lcf94	lcf94	lcf94	lcf94	lcf94	lcf94	lcf94
411	Inland marshes		lcf912	lcf912	lcf99	lcf93	lcf913	lcf912	lcf912	lcf93	lcf93
412	Peatbogs	lcf912		lcf912	lcf99	lcf93	lcf913	lcf912	lcf912	lcf93	lcf93
421	Salt marshes	lcf99	lcf912		lcf99	lcf93	lcf913	lcf912	lcf912	lcf93	lcf93
422	Salines	lcf99	lcf99	lcf911		lcf93	lcf913	lcf81	lcf911	lcf93	lcf93
423	Intertidal flats	lcf99	lcf912	lcf912	lcf99		lcf913	lcf99	lcf93	lcf93	lcf93
511	Water courses	lcf912	lcf912	lcf912	lcf99	lcf99		lcf912	lcf912	lcf93	lcf93
512	Water bodies	lcf912	lcf912	lcf912	lcf99	lcf93	lcf99		lcf99	lcf93	lcf93
521	Coastal lagoons	lcf912	lcf912	lcf912	lcf99	lcf93	lcf99	lcf99		lcf93	lcf93
522	Estuaries	lcf912	lcf912	lcf912	lcf99	lcf93	lcf99	lcf99	lcf99		lcf93
523	Sea and ocean	lcf912	lcf912	lcf912	lcf99	lcf99	lcf99	lcf99	lcf912	lcf912	

ANNEX 2: DEFINITION OF LAND COVER FLOWS

- LCF1 Urban land management:** Internal transformation of urban areas.
- lcf11 Urban development/ infilling** : Conversion from discontinuous urban fabric, green urban areas and sport and leisure facilities to dense urban fabric, economic areas and infrastructures.
 - lcf12 Recycling of developed urban land:** Internal conversions between residential and/or non-residential land cover types. Construction of urban greenfields is not considered here but as lcf11.
 - lcf13 Development of green urban areas:** Extension of green urban areas over developed land as well as, in the periphery of cities, over other types of land uses.
- LCF2 Urban residential sprawl:** Land uptake by residential buildings altogether with associated services and urban infrastructure (classified in CLC 111 & 112) from non urban land (extension over sea may happen).
- lcf21 Urban dense residential sprawl:** Land uptake by continuous urban fabric (CLC 111) from non urban land
 - lcf22 Urban diffuse residential sprawl:** Land uptake by discontinuous urban fabric (CLC 112) from non urban land.
- LCF3 Sprawl of economic sites and infrastructures:** Land uptake by new economic sites and infrastructures (including sport and leisure facilities) from non urban land (extension over sea may happen).
- lcf31 Sprawl of industrial & commercial sites:** Non urban land uptake by new industrial and commercial sites
 - lcf32 Sprawl of transport networks:** Non urban land uptake by new transport networks (note that linear features narrower than 100 m are not monitored by CLC).
 - lcf33 Sprawl of harbours:** Development of harbours over non urban land and sea.
 - lcf34 Sprawl of airports:** Development of airports over non urban land and sea.
 - lcf35 Sprawl of mines and quarrying areas:** Non urban land uptake by mines and quarries.
 - lcf36 Sprawl of dumpsites:** Non urban land uptake by waste dumpsites.
 - lcf37 Construction:** Extension over non-urban land of areas under construction during the period (note: covers mainly construction of economic sites and infrastructures).
 - lcf38 Sprawl of sport and leisure facilities:** Conversion from developed as well as non-urban land to sport and leisure facilities.
- LCF4 Agriculture internal conversions:** Conversion between farming types. Rotation between annual crops is not monitored by CLC.
- lcf41 Extension of set aside fallow land and pasture:** Conversion from crop land to grassland as an agricultural rotation or for cattle husbandry.
 - lcf411 Uniform extension of set aside fallow land and pasture:** Large parcels conversion from crop land to grassland.
 - lcf412 Diffuse extension of set aside fallow land and pasture:** Conversion from crop land to complex cultivation patterns (with grassland) and from mixed agriculture to large pasture parcels.
 - lcf42 Internal conversions between annual crops:** Conversions between irrigated and non-irrigated agriculture
 - lcf421 Conversion from arable land to permanent irrigation perimeters:** Extension of permanent irrigation (incl. rice fields) over arable land
 - lcf422 Other internal conversions of arable land:** Other conversions between arable land and irrigated perimeters, incl. rice fields

- lcf43 Internal conversions between permanent crops:** Conversions between vineyards, orchards and/or olive groves
 - lcf431 Conversion from olives groves to vineyards and orchards:** Conversion from olives groves to vineyards and orchards
 - lcf432 Conversion from vineyards and orchards to olive groves:** Conversion from vineyards and orchards to olive groves
 - lcf433 Other conversions between vineyards and orchards:** Other conversions between vineyards and orchards
 - lcf44 Conversion from permanent crops to arable land:** Conversion from vineyards, orchards and olive groves to irrigated and/or non-irrigated arable land
 - lcf441 Conversion from permanent crops to permanent irrigation:** Conversion from permanent crops (incl. when associated with arable land - CLC 241) to permanent (large) irrigation perimeters and rice fields
 - lcf442 Conversion from vineyards and orchards to non-irrigated arable land:** Conversion from vineyards and orchards to non-irrigated arable land and from associations of annual and permanent crops to uniform arable land.
 - lcf443 Conversion from olive groves to non-irrigated arable land:** Conversion from olive groves to non-irrigated arable land, incl. conversions to associations of annual and permanent crops (CLC241) and of crops and pasture (CLC242).
 - lcf444 Diffuse conversion from permanent crops to arable land:** Conversion from vineyards and orchards to associations of annual and permanent crops (CLC241) and of crops and pasture (CLC 242: complex cultivation patterns).
 - lcf45 Conversion from arable land to permanent crops:** Plantation of vineyards, orchards and olive groves on arable land.
 - lcf451 Conversion from arable land to vineyards and orchards:** Plantation of vineyards, orchards on arable land.
 - lcf452 Conversion from arable land to olive groves:** Plantation of olive groves on arable land.
 - lcf453 Diffuse conversion from arable land to permanent crops:** Conversion from uniform arable land to associations of permanent crops and annual crops (CLC241).
 - lcf46 Conversion from pasture to arable and permanent crops:** Conversion from pasture to arable and permanent crops
 - lcf461 Conversion from pasture to permanent irrigation perimeters:** Conversion of uniform pasture areas to permanent irrigation perimeters
 - lcf462 Intensive conversion from pasture to non-irrigated arable land and permanent crops:** Conversion of uniform pasture areas to non-irrigated annual and permanent crops
 - lcf463 Diffuse conversion from pasture to arable and permanent crops:** Conversion from complex cultivation patterns including pasture (CLC242) to uniform arable land and permanent crops as well as to associations of the last two (CLC241) and conversion of uniform pasture (CLC231) to complex cultivation patterns.
 - lcf47 Extension of agro-forestry:** Conversion of cultivated land and open pasture to agro-forestry systems such as dehesas (note: conversion from 243, where natural vegetation is important, is recorded under lcf522)
- LCF5 Conversion from forested & natural land to agriculture:** Extension of agriculture land use
- lcf51 Conversion from forest to agriculture:** Deforestation for agriculture purpose, including agricultural conversion of transitional woodland shrub
 - lcf511 Intensive conversion from forest to agriculture:** Deforestation, including agricultural conversion of transitional woodland shrub, for cultivation of annual and permanent crops (incl. in association, CLC241).
 - lcf512 Diffuse conversion from forest to agriculture:** Conversion from uniform forest to complex cultivation patterns, mosaic agricultural landscape and agro-forestry. Due to possible uncertainties in monitoring extension of pasture vs. recent fellings, conversion from forests to pasture land (CLC231) is recorded here.

- lcf52 Conversion from semi-natural land to agriculture:** Conversion from dry semi-natural land (except CLC324, grouped with forests) to agriculture
- lcf521 Intensive conversion from semi-natural land to agriculture:** Conversion from dry semi-natural land (except CLC324, grouped with forests) to annual crops, permanent crops and their association.
- lcf522 Diffuse conversion from semi-natural land to agriculture:** Conversion from dry semi-natural land (except CLC324, grouped with forests) to pasture and mixed agriculture with pasture.
- lcf53 Conversion from wetlands to agriculture:** Conversion of wetlands to any type of farmland (CLC2)
- lcf54 Conversion from developed areas to agriculture:** Conversion of urban land to any type of farmland (CLC2)
- LCF6 Withdrawal of farming:** Farmland abandonment and other type of withdrawal of agriculture activity in favour of forests or natural land
- lcf61 Withdrawal of farming with woodland creation:** Forest and woodland creation (incl. transitional woodland shrub) from all CLC agriculture types. Withdrawal of farming with woodland creation is a broader concept than farmland abandonment with woodland creation, which results more from decline of agriculture than afforestation programmes. Additional information is necessary to identify an abandonment process (type of agriculture, landscape type, socio-economic statistics...).
- lcf62 Withdrawal of farming without significant woodland creation:** Farmland abandonment in favour of natural or semi-natural landscape (except forests and transitional woodland shrub), as long as they are a possible transition. Some odd cases are provisionally recorded as lcf99 Other changes and unknown.
- LCF7 Forests creation and management:** Creation of forests and management of the forest territory by felling and replanting. Due to the CLC cycle of 10 years, only one part of the shrubs are tall enough to be identified as trees. In order to taking stock of all recent plantations, conversions of semi-natural land to CLC324 are conventionally recorded as afforestation (although some natural colonisation may take place). In the case of conversion from farmland, see lcf61.
- lcf71 Conversion from transitional woodland to forest:** Conversion from transitional woodland to broadleaved, coniferous or mixed forest, taking place when shrubs can be detected as trees.
- lcf72 Forest creation, afforestation:** Forest creation and afforestation take place on all previously non agricultural landscapes where new forests can be identified. Extension of transitional woodland shrub over non-agricultural land is recorded as afforestation. Conversion from transitional woodland to broadleaved, coniferous or mixed forest are not a creation of forest territory and are therefore registered separately (lcf71).
- lcf73 Forests internal conversions:** Conversions between broadleaved, coniferous and/or mixed forest (CLC311, 312 and 313)
- lcf74 Recent felling and transition:** Conversion from broadleaved, coniferous and/or mixed forest to open semi-natural and natural dry land resulting more likely from felling. The main transition is towards CLC324 Transitional woodland shrub, although some other types can be detected. Due to uncertainties, all are provisionally considered as transitional states of forests.
- LCF8 Water bodies creation and management:** Creation of dams and reservoirs and possible consequences of the management of the water resource on the water surface area.
- lcf81 Water bodies creation:** Extension of water surfaces resulting from the creation of dams and reservoirs
- lcf82 Water bodies management:** Consequences of the management of the water resource on the water surface area of reservoirs

- LCF9 Changes of Land Cover due to natural and multiple causes:** Changes in land cover resulting from natural phenomena with or without any human influence.
- lcf91 Semi-natural creation and rotation:** Changes in natural and semi-natural land cover due to natural factors
- lcf911 Semi-natural creation:** Natural colonisation of land previously used by human activities. Note that extension of CLC324 is considered as the result of farmland abandonment or direct afforestation.
- lcf912 Semi-natural rotation:** Rotation between the dry semi-natural and natural land cover types of CLC (except forest and transitional woodland shrub).
- lcf913 Extension of water courses:** Extension of water course results from natural erosion and artificial works. Due to the very incomplete detection of rivers with CLC, the lcf913 flow item has to be used very carefully.
- lcf92 Forests and shrubs fires:** Forest and shrub fires. Due to the short cycle of recovery of vegetation from fire, burnt areas (which are well identified on satellite images) cannot be compared in a 10 years interval, except for very aggregated statistics.
- lcf93 Coastal erosion:** Conversion of all land cover types to intertidal flats, estuaries or sea and ocean. The tide level when the satellite image is shot being unknown of the photointerpreters, the coastal erosion flow has to be used very carefully.
- lcf94 Decrease in permanent snow & glaciers cover:** Decrease of permanent snow and glaciers due to climate change to semi-natural and natural land covers, mainly to bare rock, sparsely vegetated areas and water systems.
- lcf99 Other changes and unknown:** In this category are recorded land cover changes that are rare or more likely improbable.

ANNEX 3: LEAC DATA MODEL

The LEAC Data Model describes the main tables present in the LEAC Database as well as the relationships existing among them. The two tables in the right side are the main tables (LARU and LEAC_DATA). Tables in the left side helps to describe the columns in the main tables. Read the point "2.1.4 Database structure" of this report for a better understanding of this data model.

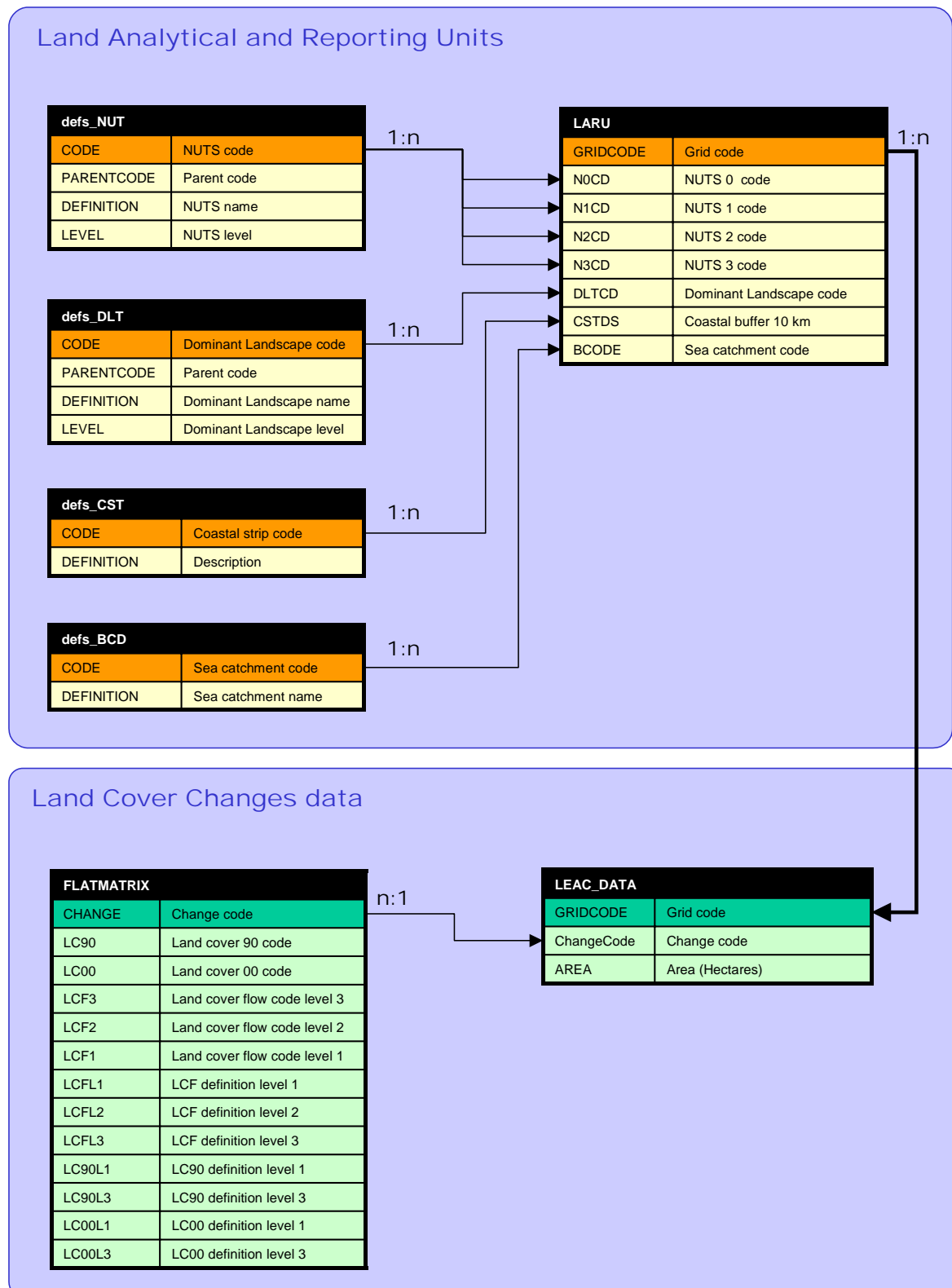

ANNEX 4: LEAC WEB BASED QUERY TOOL

LEAC takes land cover and land cover changes data from a spatial domain to an entity-relationship domain, in order to provide an easier and more comprehensive way to access this data.

Once data is stored in this entity-relationship domain, a web based query tool would be beneficial to provide easy access to this data. In a first step, querying attribute data should be enough. In a second step, it would be interesting to be able to represent this queried data in a map.

In the following diagram the basic flow of this tool is described.

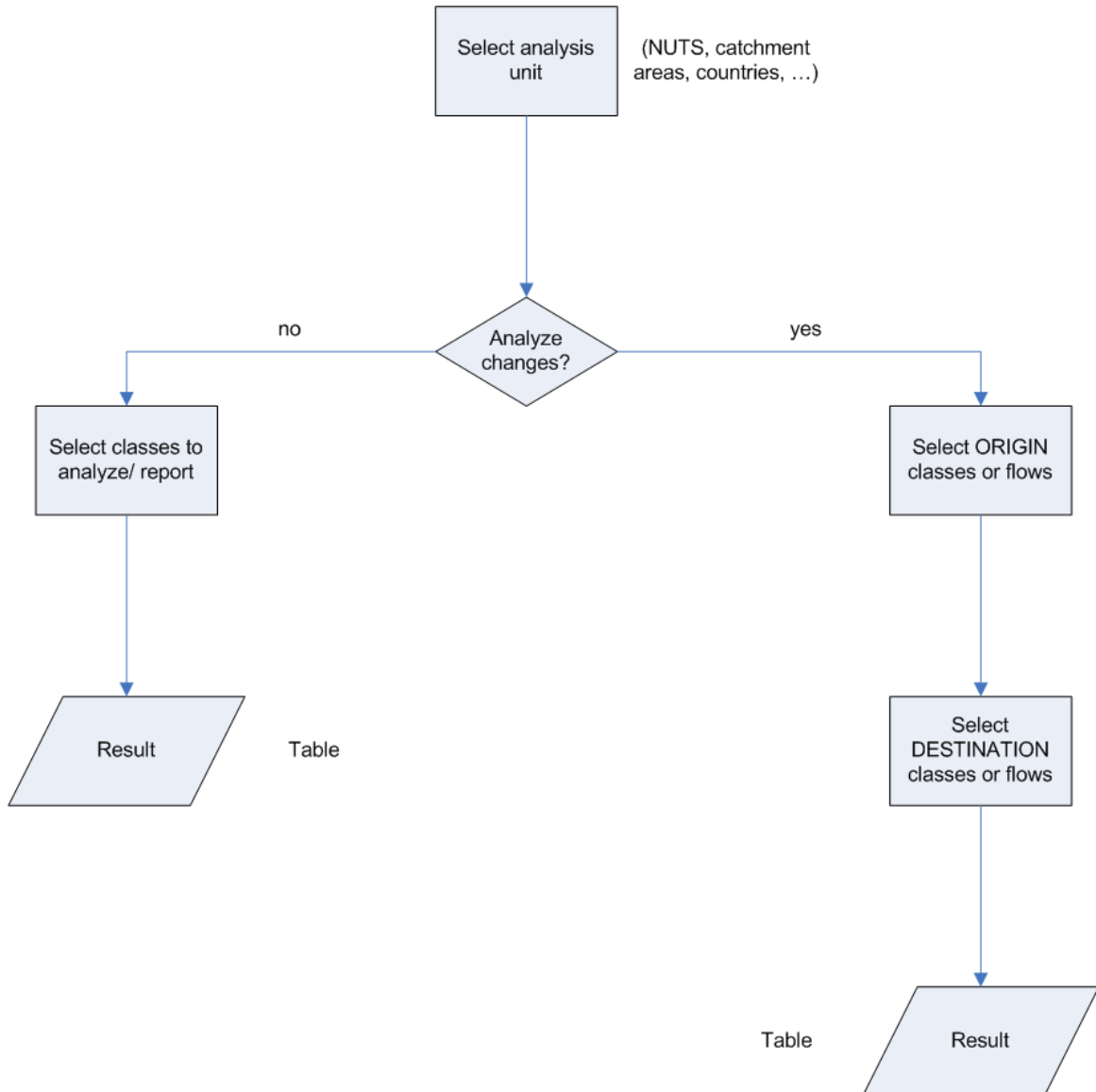

Results are tables containing the surface of the classes studied for the specific analysis unit. For example, surface of changes from agricultural to urban classes, from 1990 to 2000, for a specific NUTS3.

LEAC data model is complete enough to develop this application, and data is complete as well. However, some minor changes are suggested to provide an easier way to query the database. These changes are suggested in the diagram below.

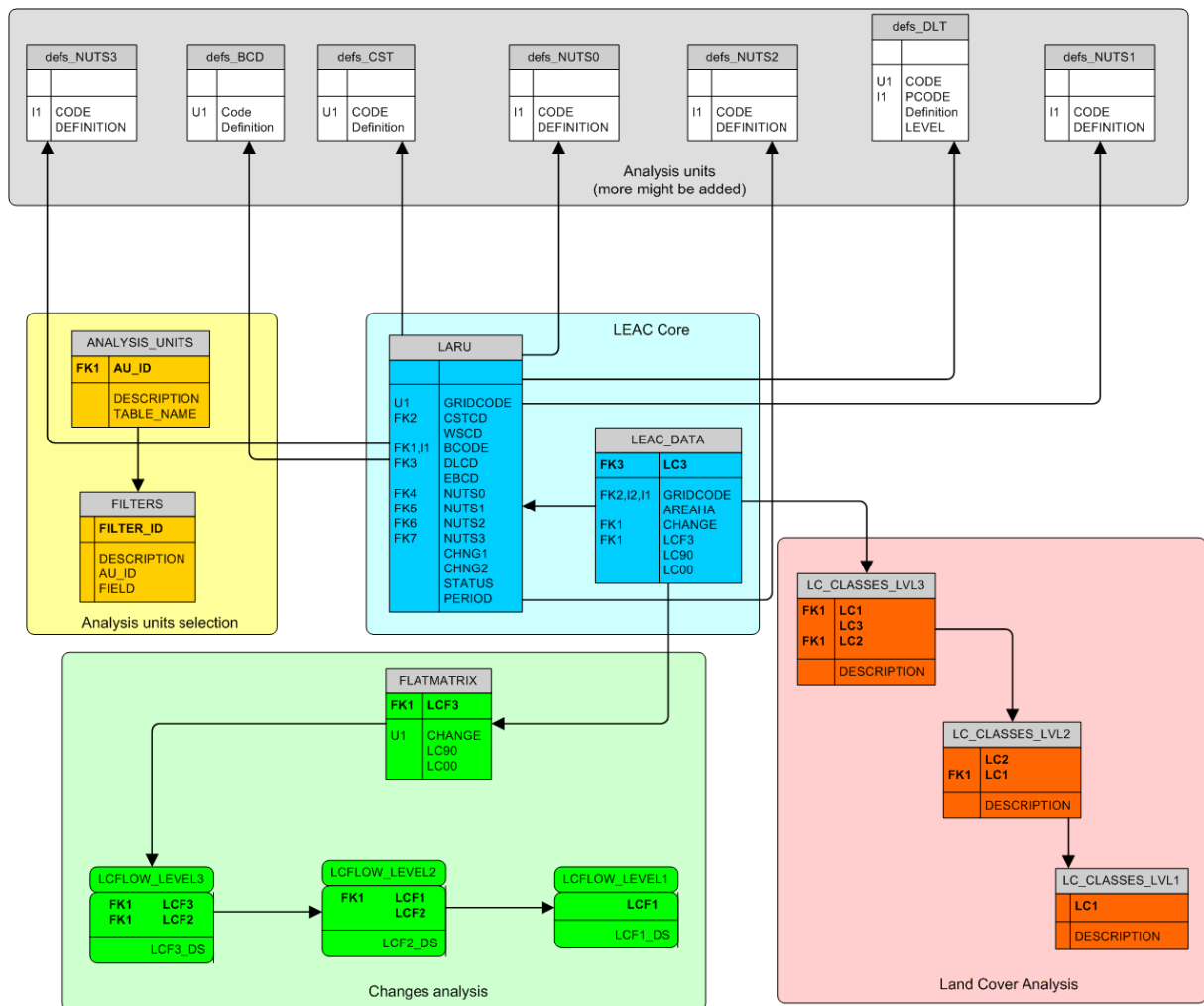

This data model allows creating this application for querying LEAC database. It would allow also to draw maps using the different analysis units. For example, a map showing LEAC data for European river catchments could be drawn.

REFERENCES

- Weber J.L., Paramo F., Breton F., Haines-Young R. (2003):** *Integration of geographical and statistical data in the environmental accounting framework; methodological development based on two case studies* **Action 2 : Integration of environmental accounts in coastal zones; case study of tourism** Contract n° 200141200017 Report of the European Topic Centre on Terrestrial Environment, with the support of the European Environment Agency, Barcelona, 28 February 2003.
- Soukup, T., Kupková, L., Weber, J.L., Páramo, F. (2003):** Integration of geographical and statistical data in the environmental accounting framework; methodological development based on two case studies **Action 1 : Accounts of the impacts on Forest and Biodiversity of Land Cover/ Land Use changes; case from the land cover changes 1975-1990 in the 4 Central and Eastern European Countries.** Contract n° 200141200016 Report of the European Topic Centre on Terrestrial Environment, with the support of the European Environment Agency, Barcelona, 28 February 2003.
- Annoni, A. et al. (2004)** Short proceedings of the 1ST European Workshop on Reference Grids. JRC ESDI Action 2142 European Spatial Data Infrastructure.